

NORITZ®

2013 INSTALLERS GUIDE

Version 1



DEMAND
excellence

Table of Contents

PROCARD PROGRAM	3
WATER HEATERS	4
SIZING CHART	7
ACCESSORIES	8
SINGLE WALL VENT	12
CONCENTRIC VENT	16
PVC VENT	18
VENT ACCESSORIES	19
DVC VENT KITS	21
SV VENT KITS	22
SUPPORT SITE	23



PROCard Program



SALES TRAININGS

In addition to Noritz Technical trainings, we offer new Sales Training classes to help you close sales effectively.



LEAD GENERATION

Supported by easy-to-access website and numerous online marketing efforts, we will provide you more organic leads.



STRONG PARTNERSHIPS

Here at Noritz, we promote strong partner relationships with our PROCard members. We want to help you elevate your business.



SALES TOOLS

Noritz offers sales tools with rich information on our tankless systems. We also have a support site that helps you easily access our technical information anytime of day.



UNLIMITED REBATES

Receive a \$100 check every 400 PROCard points. Register your heaters at procard.noritz.com and start earning your points today.

PROCard Program HOW DOES IT WORK?

- 1 Register a warranty within 90 days of the installation date.

➔ Online at procard.noritz.com
Forgot your password? E-mail procard@noritz.com to retrieve your PROCard membership number and password.

- 2 Each time your PROCard account balance reaches 400 points, we will send you a \$100 rebate check. Please allow around 2 weeks for checks to be processed.



HELPING YOUR BUSINESS GROW

Noritz is launching a new installer locator that features PROCard members in a much simpler and user-friendly way. This means more business for you! Receive HOMEOWNER LEADS from the Noritz website sent directly to your e-mail.

procard.noritz.com



DIRECT VENT
PVC



OUTDOOR
EXHAUST

NRC1111
Residential
Condensing
Water Heater
Low NOx



Model No.	Description
NRC1111-DV	SV Convertible, LowNOx, Indoor Direct Vent, 199,900 Btuh, max. 11.1 gpm
NRC1111-OD	LowNOx, Outdoor, 199,900 Btuh, max. 11.1 gpm

NRC98
Residential
Condensing
Water Heater
Low NOx



Model No.	Description
NRC98-DV	SV Convertible, Low NOx, Indoor Direct Vent, 180,000 Btuh, max. 9.8 gpm
NRC98-OD	Low NOx, Outdoor, 180,000 Btuh, max. 9.8 gpm

NRC83
Residential
Condensing
Water Heater
Low NOx



Model No.	Description
NRC83-DV	SV Convertible, Low NOx, Indoor Direct Vent, 157,000 Btuh, max. 8.3 gpm
NRC83-OD	Low NOx, Outdoor, 157,000 Btuh, max. 8.3 gpm

NRC661
Residential
Condensing
Water Heater
Low NOx

COMING SOON

Model No.	Description
NRC661-DV	SV Convertible, Low NOx, Indoor Direct Vent, 120,000 Btuh, max. 6.6 gpm
NRC661-OD	Low NOx, Outdoor, 120,000 Btuh, max. 6.6 gpm

NCC1991
Commercial
Condensing
Water Heater
Low NOx



Model No.	Description
NCC1991-DV	SV Convertible, Low NOx, Indoor Direct Vent, 199,900 Btuh, max. 11.1 gpm, stainless steel
NCC1991-OD	Low NOx, Outdoor, 199,900 Btuh, max. 11.1 gpm, stainless steel

Add "-NG" or "-LP" to the end of the model number to specify gas type.

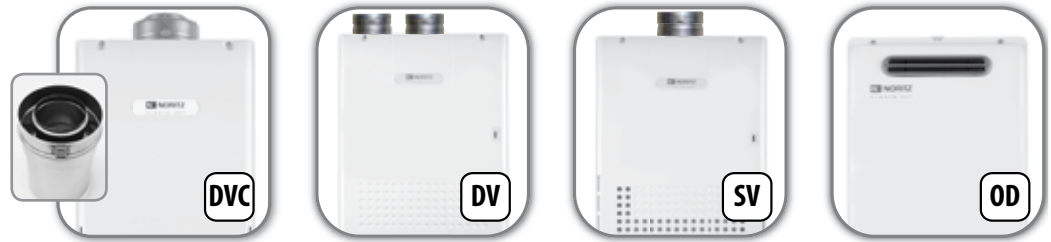

**CONCENTRIC EXHAUST
STAINLESS STEEL**

**DIRECT VENT
STAINLESS STEEL**

**SINGLE VENT
STAINLESS STEEL**

**OUTDOOR
EXHAUST**

NR111
Residential
Water Heater



Model No.	Description
NR111-DV	Indoor Direct Vent, 250,000 Btuh, max. 11.1 gpm
NR111-OD	Outdoor, 250,000 Btuh, max. 11.1 gpm
NR111-SV	Indoor, 250,000 Btuh, max. 11.1 gpm

NR981
Residential
Water Heater
Low NOx



Model No.	Description
NR981-DVC	Low NOx, Indoor Concentric Vent, 199,900 Btuh, max. 9.8 gpm
NR981-OD	Low NOx, Outdoor, 199,900 Btuh, max. 9.8 gpm
NR981-SV	Low NOx, Indoor, 199,900 Btuh, max. 9.8 gpm

NR83
Residential
Water Heater
Low NOx



Model No.	Description
NR83-DVC	Low NOx, Indoor Concentric Vent, 180,000 Btuh, max. 8.3 gpm

NR71
Residential
Water Heater



Model No.	Description
NR71-OD	Outdoor, 180,000 Btuh, max. 7.1 gpm
NR71-SV	Indoor, 180,000 Btuh, max. 7.1 gpm

NR66
Residential
Water Heater



Model No.	Description
NR66-OD	Outdoor, 140,000 Btuh, max. 6.6 gpm
NR66-SV	Indoor, 140,000 Btuh, max. 6.6 gpm

Add "-NG" or "-LP" to the end of the model number to specify gas type.



DVC
CONCENTRIC EXHAUST
STAINLESS STEEL



DV
DIRECT VENT
STAINLESS STEEL



SV
SINGLE VENT
STAINLESS STEEL



OD
OUTDOOR
EXHAUST

NR50
Residential
Water Heater



Model No.	Description
NR50-OD	Outdoor, 120,000 Btuh, max. 5.0 gpm

NC1991
Commercial
Water Heater
Low NOx



Model No.	Description
NC1991-DVC	Low NOx, Indoor Concentric Vent, 199,900 Btuh, max. 9.8 gpm
NC1991-OD	Low NOx, Outdoor, 199,900 Btuh, max. 9.8 gpm

NC250-ASME
Commercial
Water Heater



Model No.	Description
NC250-DV-ASME	Indoor Direct Vent, 250,000 Btuh, max. 11.1 gpm, ASME stainless steel
NC250-SV-ASME	Indoor, 250,000 Btuh, max. 11.1 gpm, ASME stainless steel

NC380-SV-ASME
Commercial
Water Heater



Model No.	Description
NC380-SV-ASME	Indoor, 380,000 Btuh, max. 13.2 gpm, ASME stainless steel

NHXXX-DV
Hydronic
Boiler



Model No.	Description
NH199-DV	Residential/Commercial Boiler, 199,900 Btuh, ASME certified
NH150-DV	Residential/Commercial Boiler, 150,000 Btuh, ASME certified

APPROVALS

Residential



Commercial



Boiler



Add "-NG" or "-LP" to the end of the model number to specify gas type.

Temp Rise (°F)	(NC380) Series	NR111 (NC250) Series	NRC1111 (NCC1991) Series	NRC98 NR981 (NC1991) Series	NR83 Series	NRC83 Series	NR71 Series	NR66 Series	NRC661 Series	NR50 Series
30	13.2	11.1	11.1	9.8	8.3	8.3	7.1	6.6	6.6	5.0
35	13.2	11.1	10.6	9.2	8.1	7.8	7.1	6.6	6.6	5.0
40	13.2	10.5	9.3	8.4	7.6	7.3	7.1	5.7	5.7	5.0
45	13.2	9.3	8.4	7.5	6.7	6.5	6.3	5.3	5.3	4.2
50	12.5	8.4	7.4	6.7	6.1	5.8	5.8	4.6	4.6	3.9
55	11.3	7.6	6.8	6.1	5.4	5.4	5.2	4.2	4.2	3.5
60	10.4	7.0	6.2	5.6	5.0	4.9	4.8	3.8	3.8	3.3
65	9.6	6.5	5.8	5.2	4.7	4.6	4.4	3.5	3.5	3.0
70	8.9	6.0	5.3	4.8	4.3	4.2	4.1	3.3	3.3	2.8
75	8.3	5.6	5.0	4.5	4.1	4.0	3.8	3.1	3.1	2.6
80	7.8	5.3	4.6	4.2	3.8	3.7	3.6	2.9	2.9	2.5
85	7.3	4.9	4.4	4.0	3.6	3.5	3.4	2.7	2.7	2.3
90	6.9	4.7	4.1	3.7	3.4	3.2	3.2	2.6	2.6	2.2
95	6.6	4.4	3.9	3.5	3.2	3.1	3.0	2.4	2.4	2.1
100	6.2	4.2	3.7	3.4	3.0	2.9	2.9	2.3	2.3	2.0

For peak flow rates in shaded areas, contact Noritz for proper setting.

MODEL	SUMMER WATER SUPPLY (70°F)		WINTER WATER SUPPLY (45°F)	
	Icons	Flow Rate	Icons	Flow Rate
NC380		5.3 SHOWERS AT 13.2 GPM		4.2 SHOWERS AT 10.4 GPM
NR111, NC250		4.4 SHOWERS AT 11.1 GPM		2.8 SHOWERS AT 7.0 GPM
NRC1111 NCC1991		4.1 SHOWERS AT 10.6 GPM		2.5 SHOWERS AT 6.2 GPM
NRC98, NR981, & NC1991		3.7 SHOWERS AT 9.2 GPM		2.2 SHOWERS AT 5.6 GPM
NR83		3.3 SHOWERS AT 8.1 GPM		2.0 SHOWERS AT 5.0 GPM
NRC83		3.1 SHOWERS AT 7.8 GPM		2.0 SHOWERS AT 4.9 GPM
NR71		2.8 SHOWERS AT 7.1 GPM		1.9 SHOWERS AT 4.8 GPM
NR66		2.6 SHOWERS AT 6.6 GPM		1.5 SHOWERS AT 3.8 GPM
NRC661		2.6 SHOWERS AT 6.6 GPM		1.5 SHOWERS AT 3.8 GPM
NR50		2.0 SHOWERS AT 5.0 GPM	N/A FOR WINTER WEATHER	

Assuming a standard 2.5 GPM shower head and 105°F output water temperature. NC380, NC250, NC1991 & NCC1991 are commercial models.

VENT TYPE	RESIDENTIAL MODELS										COMMERCIAL MODELS				BOILER			
	NR66	NR71	NR83	NR981		NR111		NRC661	NRC83	NRC98	NRC1111	NCC1991	NC1991	NC250	NC380	NH		
	SV	SV	DVC	DVC	SV	DV	SV	DV	DV	DV	DV	DV	DVC	DV	SV	SV	150	199
3" CAT III VENT	✓																	
4" CAT III VENT		✓			✓	✓	✓							✓	✓		✓	✓
5" CAT III VENT																✓		
CONCENTRIC SS VENT			✓	✓									✓					
3" PVC VENT								✓	✓	✓	✓							
4" PVC VENT									✓	✓	✓							

OD models do not require venting.



SUPPORT.NORITZ.COM • 866.766.7489 (press 1)

Add "-NG" or "-LP" to the end of the model number to specify gas type.

**Remote Controller
Outdoor
Junction Box**
0700757



Model No.	Description	Qty/Box*
0700757	Remote Controller Outdoor Junction Box	1

H2Flow
Water Treatment
H2F



Model No.	Description	Qty/Box*
CH2F-***	Commercial H2Flow	***
H2F	H2Flow Anti-Scale System	1
H2F-C	H2Flow Replacement Cartridge	1

***Call for commercial sizing**

Scale Shield
Water Treatment
SS



Model No.	Description	Qty/Box*
SS-HB-1	Water Treatment for NR50, NR66, NR71, NR83, NR981, NRC1111, NRC98, NRC83, NRC661, NC1991 and NCC1991 series	1
SS-HB-2	Water Treatment for NR111, NC250, NC380* series	1
HBC-1	Refill Cartridge for SS-HB-1	1
HBC-2	Refill Cartridge for SS-HB-2	1

***Two needed for this model
Only for up to 10 gpg**

**Isolator
Valve Kit**
IK-WV



Model No.	Description	Qty/Box*
IK-WV-200-1-SW	3/4" sweat iso valve kit with male 500K Btuh Pressure Relief Valve	1
IK-WV-200-1-TH	3/4" threaded iso valve kit with male 500K Btuh Pressure Relief Valve	1
IK-WV-300-1-SW	1" sweat iso valve kit with male 500K Btuh Pressure Relief Valve	1
IK-WV-300-1-TH	1" threaded iso valve kit with male 500K Btuh Pressure Relief Valve	1

**Lead-Free
Isolator
Valve Kit**
IK-WV



Model No.	Description	Qty/Box*
IK-WV-200-1-SW-LF	Lead Free 3/4" sweat iso valve kit with male 500K Btuh Pressure Relief Valve	1
IK-WV-200-1-TH-LF	Lead Free 3/4" threaded iso valve kit with male 500K Btuh Pressure Relief Valve	1
IK-WV-300-1-SW-LF	Lead Free 1" sweat iso valve kit with male 500K Btuh Pressure Relief Valve	1
IK-WV-300-1-TH-LF	Lead Free 1" threaded iso valve kit with male 500K Btuh Pressure Relief Valve	1

**Commercial
Multi-Rack
System**
MR-2



Model No.	Description	Qty/Box*
MR-2	Commercial multi-rack system	1

Refer to page 11 for complete accessories compatibility chart.

Safety Relief Valve
HTGSRV-1



Model No.	Description	Qty/Box*
HTGSRV-1	Safety Relief Valve for NH series	1

Condensate Neutralizer Kit (External)
NC-1/NT20A



Residential



Commercial

Model No.	Description	Qty/Box*
NC-1	Residential Condensate Neutralizer Kit	1
NT20A	Commercial Condensate Neutralizer Kit	1

Pipe Cover
PC



Model No.	Description	Qty/Box*
PC-1S	Pipe Cover (NR50, NR66, NR71, NRC661 series)	1
PC-2S	Pipe Cover for NR981 (SV/OD)	1
PC-2S-GRY	Stone Gray Pipe Cover for NC1991-OD	1
PC-3S	Pipe Cover (NR111, NRC83, NRC98 & NRC1111)	1
PC-3S-SUS	Stainless Steel PC for NC250, NCC1991 series	1
PC-4S-SUS	Stainless Steel PC for NC380	1
PC-5S	Pipe Cover for NR981-DVC, NR83-DVC	1
PC-5S-GRY	Stone Gray Pipe Cover for NC1991-DVC	1

Quick Connect Cable
QC



Model No.	Description	Qty/Box*
QC-1	Quick Connect Cable (2 units only)	1
QC-2	Quick Connect Cable (NR83-DVC, NR981, NRC1111, NRC98, NRC83, NCC1991)	1

Recess Box
RB



Model No.	Description	Qty/Box*
RB-500	Recess Box for NR66	1
RB-600	Recess Box for NR71	1
RB-700-1	Recess Box for NR981 & NC1991	1
RB-900-1	Recess Box for NR111, NRC1111, NRC98, NRC83 & NCC1991	1

*for OD models only

Remote Controller
RC

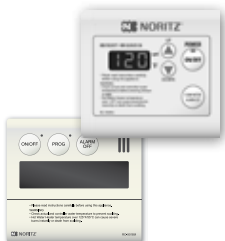

Model No.	Description	Qty/Box*
RC-7649M	Remote Controller (°F only)	1
RC-7650M	Remote Controller - Canada (°F & °C)	1
RC-9018M	Remote Controller for 2012 Residential & Commercial units*	1

*2012 Residential Units: NRC1111, NRC98, NRC83, NR981
2012 Commercial Units: NCC1991, NC1991

Refer to page 11 for complete accessories compatibility chart.

Remote Controller Cord
RC-CORD



Model No.	Description	Qty/Box*
RC-CORD10	10 ft. length	1
RC-CORD26	26 ft. length	1

Neutralizer Cartridge
SKD7466



Model No.	Description	Qty/Box*
SKD7466	Neutralizer Cartridge	1

*Replacement for or NRC111 AND NCC199

System Controller
SC



Model No.	Description	Qty
SC-201-24M	System Controller up to 24 units	1
SC-201-12M	System Controller up to 12 units	1
SC-201-6M	System Controller up to 6 units	1
SCU-301-24M	System Controller up to 24 units for NCC1991 series	1
SCU-301-12M	System Controller up to 12 units for NCC1991 series	1
SC-301-6M	System Controller up to 6 units for NCC1991 series	1
SC-301-6M-EXT	System Controller up to 6 units for NC1991 series	1

Freeze Protection Kit
SKG7772



Model No.	Description	Qty/Box*
SKG7772	Freeze Protection Kit for NR50-OD	1

*Only needed for serial number before 2012.07-002418 NG & 2012.07-002480 LP

Temp/Pressure Gauge
TPG1-30



Model No.	Description	Qty/Box*
TPG1-30	Temp/Pressure Gauge for NH	1



SUPPORT.NORITZ.COM • 866.766.7489 (press 1)

Refer to page 11 for complete accessories compatibility chart.

Accessories	Part #	Residential Models														Commercial Models						Boiler							
		NR50		NR66		NR71		NR83		NR981		NR111		NRC661		NRC83 NRC98		NRC111		NCC1991		NC1991		NC250		NC380		NH	
		OD	SV	OD	SV	OD	DVC	DVC	SV	OD	DV	SV	OD	DV	OD	DV	OD	DV	OD	DV	OD	DV	OD	DV	SV	SV	150	199	
RC Outdoor Junction Box	0700757	✓	✓	✓	✓	✓			✓		✓	✓		✓		✓		✓		✓		✓		✓	✓				
H2Flow Water Treatment	CH2F-***																												
	H2F	✓	✓	✓	✓	✓	✓	✓	✓	✓	✓	✓	✓	✓	✓	✓	✓	✓	✓	✓	✓	✓	✓	✓	✓	✓	✓		
	H2F-C	✓	✓	✓	✓	✓	✓	✓	✓	✓	✓	✓	✓	✓	✓	✓	✓	✓	✓	✓	✓	✓	✓	✓	✓	✓	✓		
Scale Shield Water Treatment	SS-HB-1	✓	✓	✓	✓	✓	✓	✓	✓																				
	SS-HB-2																												
Scale Shield Refill Cartridge	HBC-1	✓	✓	✓	✓	✓	✓	✓	✓																				
	HBC-2																												
Isolator Valve Kit	IK-WV-200-1-SW	✓	✓	✓	✓	✓	✓	✓	✓	✓	✓	✓	✓	✓	✓	✓	✓	✓	✓	✓	✓	✓	✓	✓	✓	✓	✓		
	IK-WV-200-1-TH	✓	✓	✓	✓	✓	✓	✓	✓	✓	✓	✓	✓	✓	✓	✓	✓	✓	✓	✓	✓	✓	✓	✓	✓	✓	✓		
	IK-WV-300-1-SW																									✓	✓		
	IK-WV-300-1-TH																									✓	✓		
Lead-Free Isolator Valve Kit	IK-WV-200-1-SW-LF	✓	✓	✓	✓	✓	✓	✓	✓	✓	✓	✓	✓	✓	✓	✓	✓	✓	✓	✓	✓	✓	✓	✓	✓	✓	✓		
	IK-WV-200-1-TH-LF	✓	✓	✓	✓	✓	✓	✓	✓	✓	✓	✓	✓	✓	✓	✓	✓	✓	✓	✓	✓	✓	✓	✓	✓	✓	✓		
	IK-WV-300-1-SW-LF																									✓	✓		
	IK-WV-300-1-TH-LF																									✓	✓		
Commercial Multi-Rack System	MR-2																					✓	✓	✓	✓	✓	✓		
Safety Relief Valve	HTGSRV-1																										✓		
Condensate Neutralizer Kit	NC-1																												
	NT20A																					✓	✓						
Pipe Cover	PC-1S	✓	✓	✓	✓	✓																							
	PC-2S								✓	✓																			
	PC-2S-GRY																												
	PC-3S											✓	✓	✓															
	PC-3S-SUS																					✓	✓						
	PC-4S-SUS																									✓			
	PC-5S					✓	✓																						
	PC-5S-GRY																												
Quick Connect Cable	QC-1						✓	✓	✓	✓	✓	✓	✓	✓								✓	✓	✓	✓	✓	✓		
	QC-2					✓																							
Recess Box	RB-500			✓																									
	RB-500-1																												
	RB-600																												
	RB-700-1										✓																		
	RB-900																												
	RB-900-1																												
Remote Controller	RC-7649M	✓	✓	✓	✓	✓						✓	✓	✓										✓	✓	✓			
	RC-7650M						✓	✓	✓	✓																			
	RC-9018M																												
Remote Controller Cord	RC-CORD10	✓	✓	✓	✓	✓				✓	✓	✓	✓	✓	✓	✓	✓	✓	✓	✓	✓	✓	✓	✓	✓	✓			
	RC-CORD26	✓	✓	✓	✓	✓				✓	✓	✓	✓	✓	✓	✓	✓	✓	✓	✓	✓	✓	✓	✓	✓	✓			
System Controller	SC-201-24M											✓	✓	✓												✓	✓		
	SC-201-12M											✓	✓	✓												✓	✓		
	SC-201-6M											✓	✓	✓												✓	✓		
	SCU-301-24M																												
	SCU-301-12M																												
	SC-301-6M																												
	SC-301-6M-EXT																												
Freeze Protection Kit	SKG7772	✓																											
Temp/Pressure Gauge	TPG1-30																										✓		

*Included with heater purchase. **Two units required. ***RC-Cords will need to be purchased. ****Contact Noritz for commercial sizing.

Rigid Vent Pipe

Stainless Steel Single-Wall
VPX-XXSTR

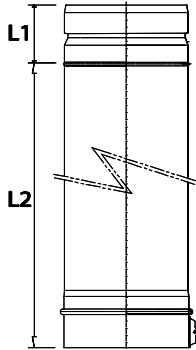

Model No.	Venting Series	L1	L2	Qty / Box
VP3-12STR	3" SUS	2.0"	12.0"	6
VP3-24STR	3" SUS	2.0"	24.0"	6
VP3-36STR	3" SUS	2.0"	36.0"	6
VP3-48STR	3" SUS	2.0"	48.0"	6
VP4-6STR	4" SUS	2.1"	6.0"	6
VP4-12STR	4" SUS	2.1"	12.0"	6
VP4-24STR	4" SUS	2.1"	24.0"	6
VP4-36STR	4" SUS	2.1"	36.0"	6
VP4-48STR	4" SUS	2.1"	48.0"	6
VP5-6STR	5" SUS	2.7"	6.0"	6
VP5-12STR	5" SUS	2.7"	12.0"	6
VP5-24STR	5" SUS	2.7"	24.0"	6
VP5-36STR	5" SUS	2.7"	36.0"	6
VP5-48STR	5" SUS	2.7"	48.0"	6

Adjustable Vent Pipe

Stainless Steel Single-Wall
VPX-XXADJ

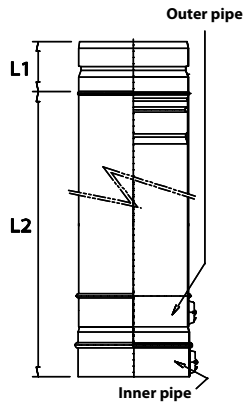

Model No.	Venting Series	L1	L2	Qty / Box
VP3-9.4ADJ	3" SUS	2.0"	6.8" - 9.1"	6
VP3-13.4ADJ	3" SUS	2.0"	9.5" - 14.6"	6
VP3-21.4ADJ	3" SUS	2.0"	15.4" - 26.5"	6
VP3-60ADJ	3" SUS	2.0"	36.0" - 60.0"	6
VP4-9.4ADJ	4" SUS	2.1"	6.8" - 9.1"	6
VP4-13.4ADJ	4" SUS	2.1"	9.5" - 14.6"	6
VP4-21.4ADJ	4" SUS	2.1"	15.4" - 26.5"	6
VP4-60ADJ	4" SUS	2.1"	36.0" - 60.0"	6
VP5-9.4ADJ	5" SUS	2.7"	6.8" - 9.1"	6
VP5-13.4ADJ	5" SUS	2.7"	9.5" - 14.6"	6
VP5-21.4ADJ	5" SUS	2.7"	15.4" - 26.5"	6

Semi-Flexible Vent Pipe

Stainless Steel Single-Wall
VPX-18FLEX

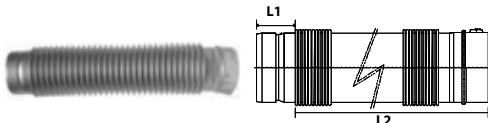

Model No.	Venting Series	L1	L2	Qty / Box
VP4-18FLEX	4" SUS	2.1"	6.2"	6
VP5-18FLEX	5" SUS	2.1"	6.2"	6

3" SUS	For NR66 Series
4" SUS	For NR71, NR981, NR111, NC250, NH Boiler Series

5" SUS	For NC380 Series
Concentric SUS	For DVC Series

45° Vent Pipe Elbow

Stainless Steel Single-Wall
VPX-45ELB

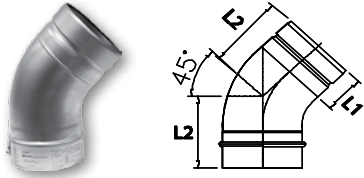

Model No.	Venting Series	L1	L2	Qty / Box
VP3-45ELB	3" SUS	2.0"	3.6"	6
VP4-45ELB	4" SUS	2.1"	4.0"	6
VP5-45ELB	5" SUS	2.7"	5.4"	6

90° Vent Pipe Elbow

Stainless Steel Single-Wall
VPX-90ELB

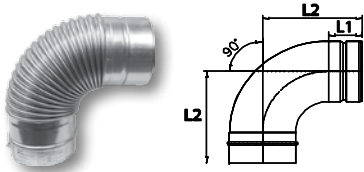

Model No.	Venting Series	L1	L2	Qty / Box
VP3-90ELB	3" SUS	2.0"	5.2"	6
VP4-90ELB	4" SUS	2.1"	6.2"	6
VP5-90ELB	5" SUS	2.7"	7.9"	6

*non-flexible

Vent Pipe Vertical Drain Tee

Stainless Steel Single-Wall
DTX-V

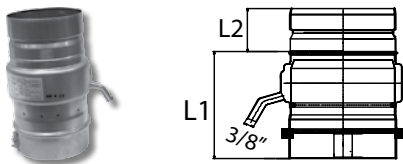

Model No.	Venting Series	L1	L2	Qty / Box
DT3-V	3" SUS	2.0"	5.1"	6
DT4-V	4" SUS	2.1"	5.1"	6
DT5-V	5" SUS	2.7"	6.2"	6

Vent Pipe Horizontal Drain Tee

Stainless Steel Single-Wall
DTX

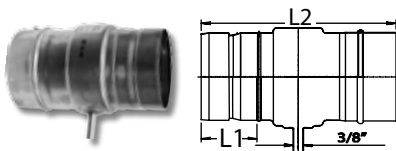

Model No.	Venting Series	L1	L2	Qty / Box
DT3	3" SUS	2.0"	7.1"	6
DT4	4" SUS	2.1"	7.2"	6
DT5	5" SUS	2.7"	8.0"	6

Vent Pipe Rain Cap

Stainless Steel Single-Wall
RC-X

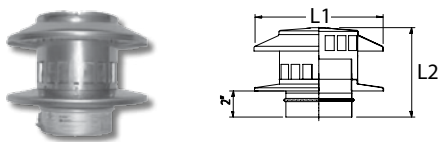

Model No.	Venting Series	L1	L2	Qty / Box
RC3	3" SUS	6.3"	6.8"	6
RC4	4" SUS	7.8"	6.6"	6
RC5	5" SUS	11.0"	7.2"	6

Storm Collar Vent Pipe

Stainless Steel Single-Wall
SCPX

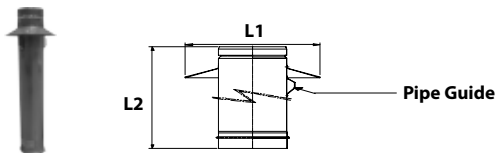

Model No.	Venting Series	L1	L2	Qty / Box
SCP4	4" SUS	2.1"	23.6"	6
SCP5	5" SUS	2.7"	25.2"	6

3" SUS	For NR66 Series
4" SUS	For NR71, NR981, NR111, NC250, NH Boiler Series

5" SUS	For NC380 Series
Concentric SUS	For DVC Series

Straight Termination w/ Birdscreen

Stainless Steel Single-Wall Vent Pipe
VTX-S

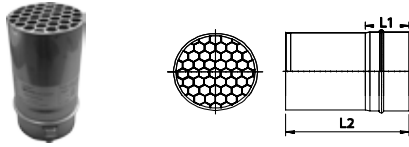

Model No.	Venting Series	L1	L2	Qty / Box
VT3-S	3" SUS	2.0"	5.9"	6
VT4-S	4" SUS	2.1"	6.2"	6
VT5-S	5" SUS	2.7"	7.9"	6

45° Vent Pipe Termination w/ Birdscreen

Stainless Steel Single-Wall
VTX-S45

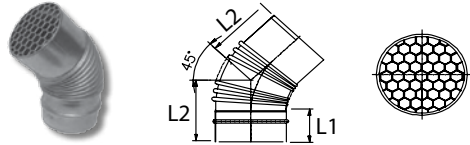

Model No.	Venting Series	L1	L2	Qty / Box
VT4-S45	4" SUS	2.1"	4.0"	6
VT5-S45	5" SUS	2.7"	5.4"	6

***non-flexible**

Vent Pipe Termination w/ Hood

Stainless Steel Single-Wall
VTX-SH

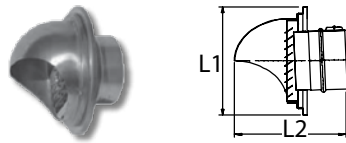

Model No.	Venting Series	L1	L2	Qty / Box
VT3-SH	3" SUS	3.2"	5.5"	6
VT4-SH	4" SUS	7.4"	6.1"	6
VT5-SH	5" SUS	7.4"	6.6"	6

Vent Pipe Termination w/ Louver

Stainless Steel Single-Wall
VTX-SL

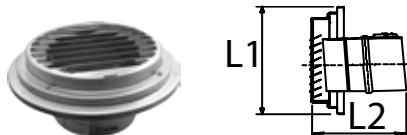

Model No.	Venting Series	L1	L2	Qty / Box
VT4-SL	4" SUS	7.4"	3.2"	6
VT5-SL	5" SUS	7.4"	3.7"	6

Vent Pipe Wall Thimble

Stainless Steel Single-Wall
WTX

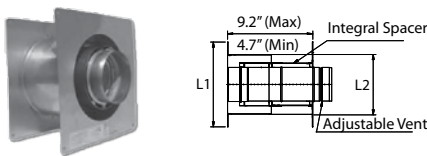

Model No.	Venting Series	L1	L2	Qty / Box
WT3	3" SUS	6.0"	4.0"	1
WT4	4" SUS	10.0"	7.0"	1
WT5	5" SUS	12.2"	10.7"	1

Adjustable Wall Thimble w/ Termination

Stainless Steel Single-Wall Vent Pipe
WTX-H-XX

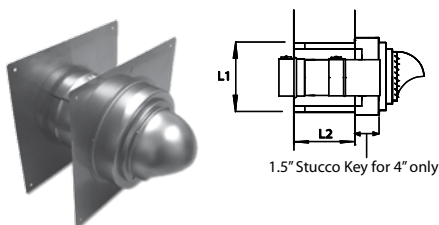

Model No.	Venting Series	L1	L2	Qty / Box
WT3-H-6	3" SUS	6.5"	5.0" - 6.0"	1
WT3-H-9	3" SUS	6.5"	7.0" - 9.0"	1
WT3-H-14	3" SUS	6.5"	9.0" - 14.5"	1
WT4-H-8-1	4" SUS	5.8"	4.1" - 7.8"	1
WT4-H-14-1	4" SUS	5.8"	7.8" - 14.0"	1
WT5-H-6	5" SUS	10.7"	6.0" - 8.0"	1
WT5-H-7	5" SUS	10.7"	7.0" - 8.0"	1
WT5-H-14	5" SUS	10.7"	10.5" - 14.5"	1

3" SUS	For NR66 Series
4" SUS	For NR71, NR981, NR111, NC250, NH Boiler Series

5" SUS	For NC380 Series
Concentric SUS	For DVC Series

Rigid Vent Pipe

Stainless Steel Double-Wall
CVP-XXSTR

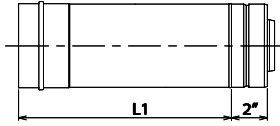

Model No.	Venting Series	L1	L2	Qty / Box
CVP-4STR	Concentric SUS	3.3"	-	6
CVP-12STR	Concentric SUS	11.8"	-	6
CVP-24STR	Concentric SUS	23.6"	-	6
CVP-36STR	Concentric SUS	35.4"	-	6

Adjustable Vent Pipe

Stainless Steel Double-Wall
CVP-XXADJ

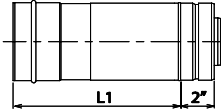

Model No.	Venting Series	L1	L2	Qty / Box
CVP-11ADJ	Concentric SUS	8.3" - 11.2"	-	6
CVP-16ADJ	Concentric SUS	11.0" - 16.7"	-	6
CVP-40ADJ	Concentric SUS	22.8" - 40.6"	-	6

45° Vent Pipe Elbow

Stainless Steel Double-Wall
CVP-45ELB

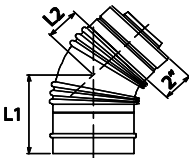

Model No.	Venting Series	L1	L2	Qty / Box
CVP-45ELB	Concentric SUS	5.3"	2.2"	6

***non-flexible**

90° Vent Pipe Elbow

Stainless Steel Double-Wall
CVP-90ELB

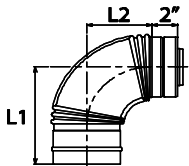

Model No.	Venting Series	L1	L2	Qty / Box
CVP-90ELB	Concentric SUS	8.1"	4.9"	6

***non-flexible**

90° Adjustable Vent Pipe Elbow

Stainless Steel Double-Wall
CVP-90ADJELB

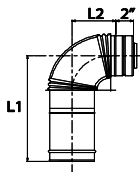

Model No.	Venting Series	L1	L2	Qty / Box
CVP-90ADJELB	Concentric SUS	12.6" - 15.8"	4.9"	6

***non-flexible**

90° Adjustable Vent Pipe Elbow w/ Wall Flange

Stainless Steel Double-Wall
CWF-90ELB

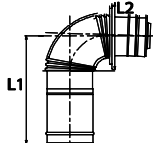

Model No.	Venting Series	L1	L2	Qty / Box
CWF-90ELB	Concentric SUS	12.6" - 15.8"	8.7"	6

***non-flexible**

3" SUS	For NR66 Series
4" SUS	For NR71, NR981, NR111, NC250, NH Boiler Series

5" SUS	For NC380 Series
Concentric SUS	For DVC Series

Vent Pipe Vertical Drain Tee

Stainless Steel Double-Wall
CDT-V

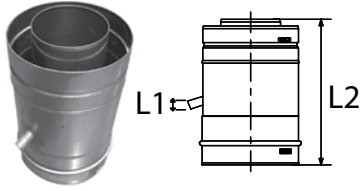

Model No.	Venting Series	L1	L2	Qty / Box
CDT-V	Concentric SUS	0.47"	8.3"	6

Vent Pipe Rain Cap

Stainless Steel Double-Wall
CRCAI-1

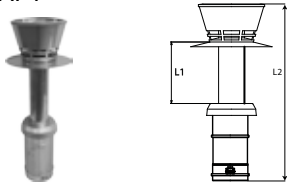

Model No.	Venting Series	L1	L2	Qty / Box
CRCAI-1	Concentric SUS	10.6"	26.5"	1

Straight Termination w/ Birdscreen

Stainless Steel Double-Wall Vent Pipe
CVT-S

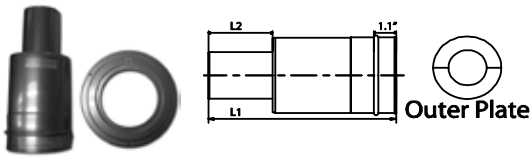

Model No.	Venting Series	L1	L2	Qty / Box
CVT-S	Concentric SUS	11.0"	3.9"	6

Vent Pipe w/ Wall Flange

Stainless Steel Double-Wall
CWF



Model No.	Venting Series	L1	L2	Qty / Box
CWF	Concentric SUS	2.0"	8.7"	6

Builder's Edition Wall Thimble

Stainless Steel Double-Wall Vent Pipe
CWT-H



Model No.	Venting Series	L1	L2	Qty / Box
CWT-H	Concentric SUS	Min. 3.5"	1.5"	1

3" SUS	For NR66 Series
4" SUS	For NR71, NR981, NR111, NC250, NH Boiler Series

5" SUS	For NC380 Series
Concentric SUS	For DVC Series

PVC Concentric Horizontal

Termination Kit
VK3-H-PVC

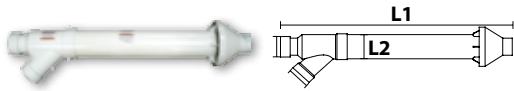

Model No.	Venting Series	L1	L2	Qty / Box
VK3-H-PVC	3" PVC	39"	4.5"	1

Plastic Horizontal Termination

PVT-HL

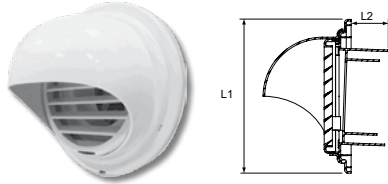

Model No.	Venting Series	L1	L2	Qty / Box
PVT-HL	3" PVC 4" PVC	7.5"	2.0"	6

*** Not approved for Canada**

Stainless Steel Bird Screen for PVC Termination

VTX-PVCS

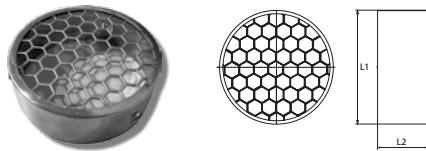

Model No.	Venting Series	L1	L2	Qty / Box
VT3-PVCS	3" PVC	2.8"	3.0"	6
VT4-PVCS	4" PVC	3.8"	3.0"	6

DV to SV Conversion Kit

SV-CK-3

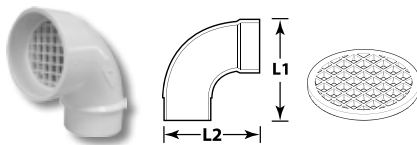

Model No.	Venting Series	L1	L2	Qty / Box
SV-CK-3	3" PVC*	6.7"	6.4"	6

***For all NRCs & NCC1991 Only**

Plastic Rain Cap

PRC-1

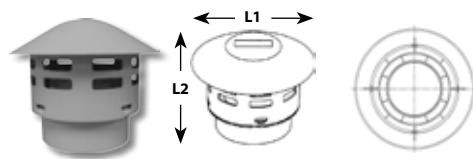

Model No.	Venting Series	L1	L2	Qty / Box
PRC-1	3" PVC 4" PVC	7.7"	6.2"	1



SUPPORT.NORITZ.COM • 866.766.7489 (press 1)

3" PVC	For NRC111, NCC199, NRC98, NRC83, NRC1111, NCC1991
4" PVC	For NRC111, NCC199, NRC98, NRC83, NRC1111, NCC1991

Stainless Steel Angled Roof Flashing

ARFX

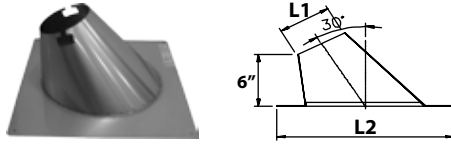

Model No.	Venting Series	L1	L2	Qty
ARF3	3" SUS	5.0"	16.0"	1
ARF5	5" SUS	7.0"	18.0"	1
CARF-1	Concentric SUS*	8.0"	16.0"	1
ADJRF34	3" & 4" SUS*	5.7"	14.3"	1

*0-45 Degree Roof Pitch

Stainless Steel Flat Roof Flashing

FRFX

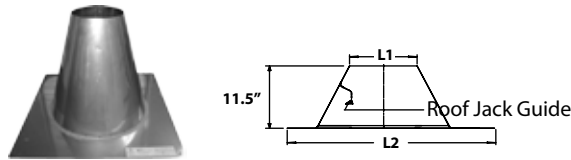

Model No.	Venting Series	L1	L2	Qty
FRF5	5" SUS	6.3"	18.0"	1

Stainless Steel Cosmetic Ring

CRX-

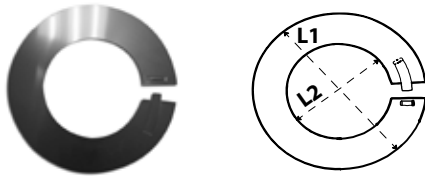

Model No.	Venting Series	L1	L2	Qty / Box
CR3-SUS	3" SUS	6.9"	3.9"	1
CR4-SUS	4" SUS	7.2"	4.3"	1
CR5-SUS	5" SUS Concentric SUS	9.9"	5.4"	1
CR3-PVC	3" PVC	7.0"	4.0"	1
CR4-PVC	4" PVC	7.8"	4.8"	1

Stainless Steel Fire Stop

FSX

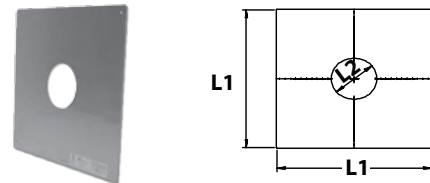

Model No.	Venting Series	L1	L2	Qty
FS3	3" SUS	15.0"	3.4"	6
FS4	4" SUS	18.0"	4.4"	6
FS5	5" SUS	20.4"	5.4"	6

Stainless Steel Support Clamp

SCX

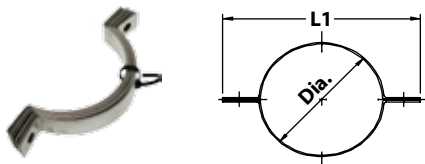

Model No.	Venting Series	L1	L2	Qty
SC3	3" SUS	6.0"	-	5 Sets
SC4	4" SUS	6.0"	-	5 Sets
SC5	5" SUS	7.0"	-	5 Sets

Stainless Steel Storm Collar Ring

SCRX

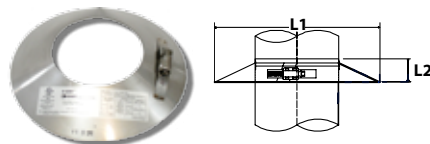

Model No.	Venting Series	L1	L2	Qty
SCR3	3" SUS	7.8"	3.0"	6
CSCR	5" SUS	9.1"	4.0"	6
CSCR-1	Concentric SUS	9.1"	4.0"	6
*SCR3-1	3" SUS	9"	3.25"	6
*SCR4-1	4" SUS	8"	3.25"	6

*Galvalume for ADJRF34 only

3" SUS	For NR66 Series
4" SUS	For NR71, NR981, NR111, NC250, NH Boiler Series

5" SUS	For NC380 Series
Concentric SUS	For DVC Series

3" SUS Venting Series

Stainless Steel Support Straps

SS3-X

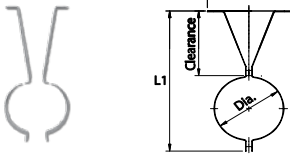

Model No.	Clearance	L1	L2	Qty
SS3-1	1"	4.6"	4.0"	5 Sets
SS3-2	2"	5.6"	4.0"	5 Sets
SS3-3	3"	6.6"	4.0"	5 Sets
SS3-4	4"	7.6"	4.0"	5 Sets

4" SUS Venting Series

Stainless Steel Support Straps

SS4-X

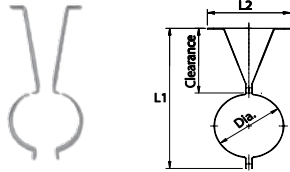

Model No.	Clearance	L1	L2	Qty
SS4-1	1"	5.7"	4.7"	5 Sets
SS4-2	2"	6.6"	4.7"	5 Sets
SS4-4	4"	8.7"	4.7"	5 Sets
SS4-6	6"	10.7"	4.7"	5 Sets

5" & Concentric SUS Venting Series

Stainless Steel Support Straps

SS5-X

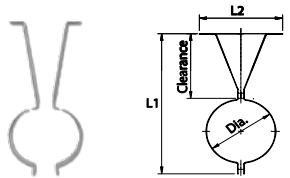

Model No.	Clearance	L1	L2	Qty
SS5-1	1"	6.8"	6.0"	5 Sets
SS5-2	2"	7.8"	6.0"	5 Sets
SS5-4	4"	9.8"	6.0"	5 Sets
SS5-6	6"	11.8"	6.0"	5 Sets

Stainless Steel Roof Jack

RJX

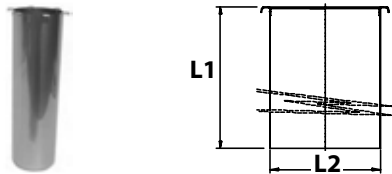

Model No.	Venting Series	L1	L2	Qty
RJ3	3" SUS	18.0"	4.0"	6
RJ5	5" SUS	18.0"	6.0"	6
ADJRF34	3" & 4" SUS	18.2"	4.6"	6

Stainless Steel Bug Guard

BG

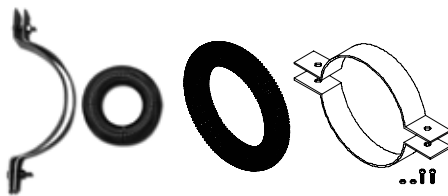

Model No.	Venting Series	Description	Qty
BG-DV	4" SUS	For TS/TL Termination	1
BG-DVC-H	Concentric SUS	For CVK-H Series	1
BG-DVC-V	Concentric SUS	For CVK-V Series	1

* Image & drawing shown: BG-DVC-V

Stainless Steel Face Plates

FP-X

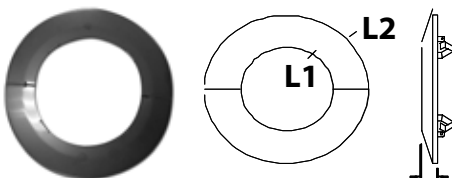

Model No.	Venting Series	L1	L2	Qty
FP-4	4" SUS*	4.9"	7.9"	1
FP-5-OUT	Concentric SUS	6.7"	8.7"	1

* For VT4-TS/TL Terminations Only

3" SUS	For NR66 Series
4" SUS	For NR71, NR981, NR111, NC250, NH Boiler Series

5" SUS	For NC380 Series
Concentric SUS	For DVC Series

Horizontal- Kits

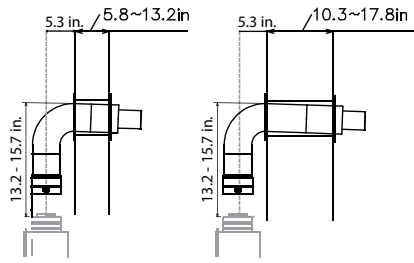

Standard Wall Kit
Includes inner & outer plates
CVK-H

Wall Thickness Range
From 5.8"-13.2"

Thick Wall Kit
Includes inner & outer plates
CVK-H2

Wall Thickness Range
From 10.3"-17.8"

Horizontal- Build Your Own

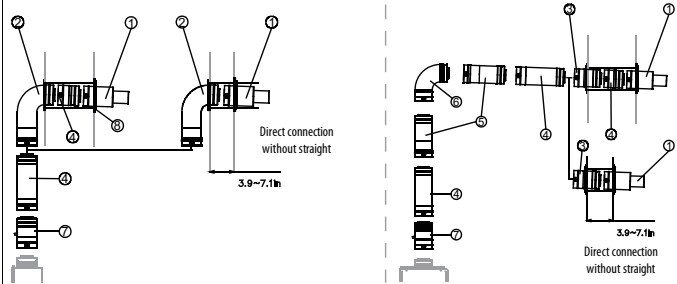

No	1	2	3	4	5	6	7
Description	Straight Bird Screen w/ Outer Plate	90° Adj w/ Wall Flange	Straight Vent Pipe w/ Wall Flange	Straight	Adjustable	45/ 90 Degree	Drain Tee
Part Number	CVT-S	CWF-90ELB	CWF	CVP-4/12/24/36STR	CVP-11/16/40ADJ	CVP-45/90ELB	CDT-V



Vent Pipe Horizontal Kit
Stainless Steel Double-Wall
CVK-H

Model No.	Venting Series	Qty/Box
CVK-H	Concentric SUS*	1
CVK-H2	Concentric SUS**	1

* (5.8" - 13.2" Wall Thickness)
** (10.3" - 17.8" Wall Thickness)

Vertical Kit
CVK-V-1
(0-45 Degrees)

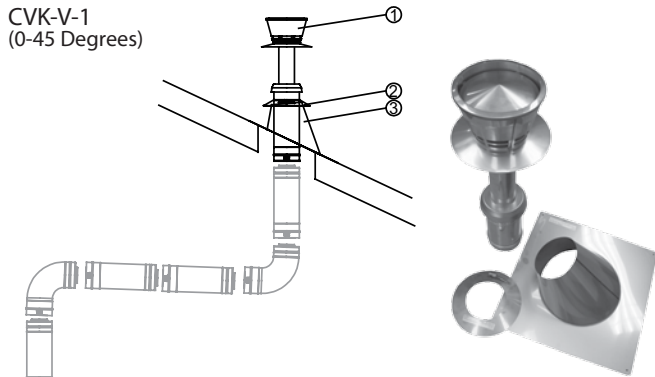

CVK-V-1 Contents		
No	Description	Part Number
1	Concentric Rain Cap	CRCAI-1
2	Storm Collar	CSCR-1
3	Adjustable Roof Flashing (0-45 Degrees)	CARF-1



Vent Pipe Vertical Kit
Stainless Steel Double-Wall
CVK-V-1

Model No.	Venting Series	Qty/Box
CVK-V-1	Concentric SUS*	1

* (0 - 45 Degree Roof Pitch)

Snorkel Kit

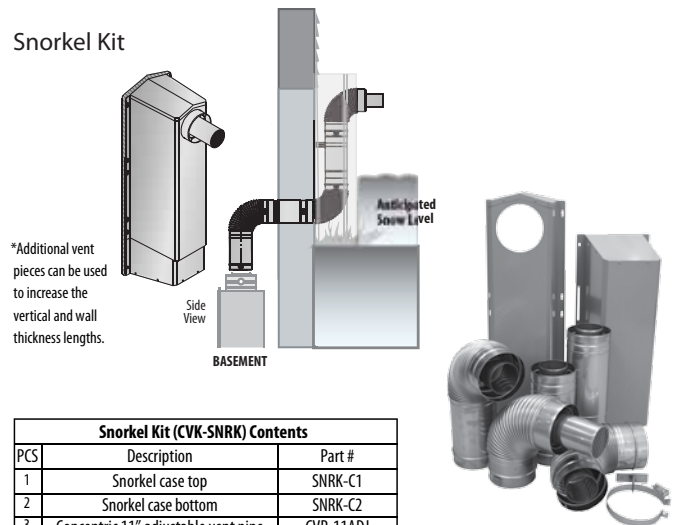

*Additional vent pieces can be used to increase the vertical and wall thickness lengths.

Snorkel Kit (CVK-SNRK) Contents		
PCS	Description	Part #
1	Snorkel case top	SNRK-C1
2	Snorkel case bottom	SNRK-C2
3	Concentric 11" adjustable vent pipe	CVP-11ADJ
4	Concentric 16" adjustable vent pipe	CVP-16ADJ
5	Concentric snorkel termination elbow	CVT-SNRK-90ELB
6	Concentric 90 degree elbow	CVP-90ELB
7	Concentric 90 degree adjustable elbow	CVP-90ADJELB
8	Adjustable support strap	SSS-3ADJ
9	Screw set	S-12



Stainless Steel Double-Wall
Vent Pipe Horizontal Snorkel Kit
CVK-SNRK

Model No.	Venting Series	Qty/Box
CVK-SNRK	Concentric SUS	1

3" SUS	For NR66 Series
4" SUS	For NR71, NR981, NR111, NC250, NH Boiler Series

5" SUS	For NC380 Series
Concentric SUS	For DVC Series

N-Vent Vertical Vent Kit
VK4-V1

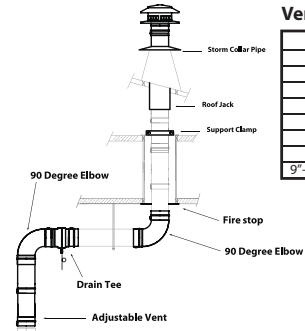

Vertical Kit Contains:

Description	Part Number	Quantity
Drain Tee	DT4	1
90 Degree Elbow	VP4-90ELB	2
Firestop	FS4	1
Support Clamp	SC4	1
Roof Jack	RJ4	1
Storm Collar Pipe	SCP4	1
Rain Cap	RC4	1
9"- 13.4" Adjustable Vent	VP4-13.4ADJ	1



Vent Pipe Vertical Kit
Stainless Steel Single-Wall

VK4-V1

Model No.	Venting Series	Qty/Box
VK4-V1	4" SUS	1

N-Vent Horizontal Vent Kit
VK4-H-*

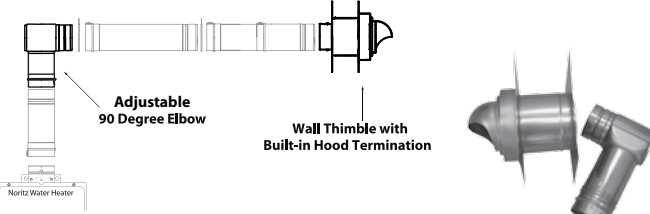

Horizontal Kit Contains:

Description	Part Number	Quantity
Wall Thimble with Built-in Hood Termination	WT4-H-#-1 (# Based on wall thickness)	1
Vertical Adjustment Range (7.5" - 11")	VP4-90ADJELB	1

Wall Thickness	Venting Kit Number
4.1" - 7.4"	VK4-H-8-1
7.4" - 14"	VK4-H-14-1



Vent Pipe Horizontal Kit
Stainless Steel Single-Wall

VK4-H-XX-1

Model No.	Venting Series	Qty/Box
VK4-H-8-1	4" SUS*	1
VK4-H-14-1	4" SUS**	1

* (4.1" - 7.4" Wall Thickness)
** (7.4" - 14" Wall Thickness)



SUPPORT.NORITZ.COM • 866.766.7489 (press 1)

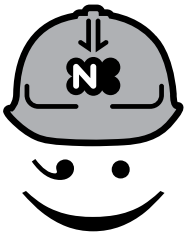

TECHNICAL SUPPORT

Noritz America provides two customer-service initiatives – a Technical Support Web Site and an In-House Call Center – with the goal of delivering information more quickly and efficiently to customers, whether their preferred method is the telephone or online.

Hours of operation: Mon-Fri 5 am – 6pm PST, Sat 7am – 3pm PST



PART SEARCH TOOL

Allows you to search for parts easily. Access a complete overview of technical specs info, installation, accessories, approvals & warranty.



TECHNICAL LITERATURE

The Technical Literature section of the site offers five different, downloadable items for each product: spec sheet, owner's guide, installation manual, parts list and certification listings.



WARRANTY CALCULATOR

This calculator is designed to approximate the length of the warranty terms. Now more precise when you add an installation date or maintenance monitor data.



ADVANCED SEARCH FUNCTION

Allows you to search information by articles associated with a model number.

PROCARD MEMBERS EXCLUSIVE BENEFITS*



TROUBLESHOOTING SECTION

Containing even more in-depth technical information than the rest of the site, this area is specifically reserved for members of the Noritz PROCARD customer-loyalty program.



LIVE CHAT

Chat with a senior member of the Engineering & Service Division - available 8 am - 5 pm PST Monday - Friday, we'll answer any technical question you have!



SERVICE REP LOCATOR

Includes filters and search criteria selected by the user so they can find you when they need you. Added with a fair online rating system that makes sense.

*These benefits are only available when you login with your PROCARD I.D. and password. Forgot your password? E-mail procard@noritz.com to retrieve your membership number & password.

SUPPORT.NORITZ.COM • 866.766.7489 (press 1)



Headquarters

11160 Grace Avenue
Fountain Valley, CA 92708
Phone: 714.433.2905
Fax: 714.241.1514



www.noritz.com/pro
Toll Free: 888.382.6568

