



LENOX 

PRODUCT CATALOG

BAND SAW BLADES
POWER TOOL ACCESSORIES
HAND TOOLS



TABLE^{OF} **CONTENTS**

UPBLADE WITH LENOX

1-9

BAND SAW

12-45

POWER TOOL ACCESSORIES

46-87

HAND TOOLS

90-104

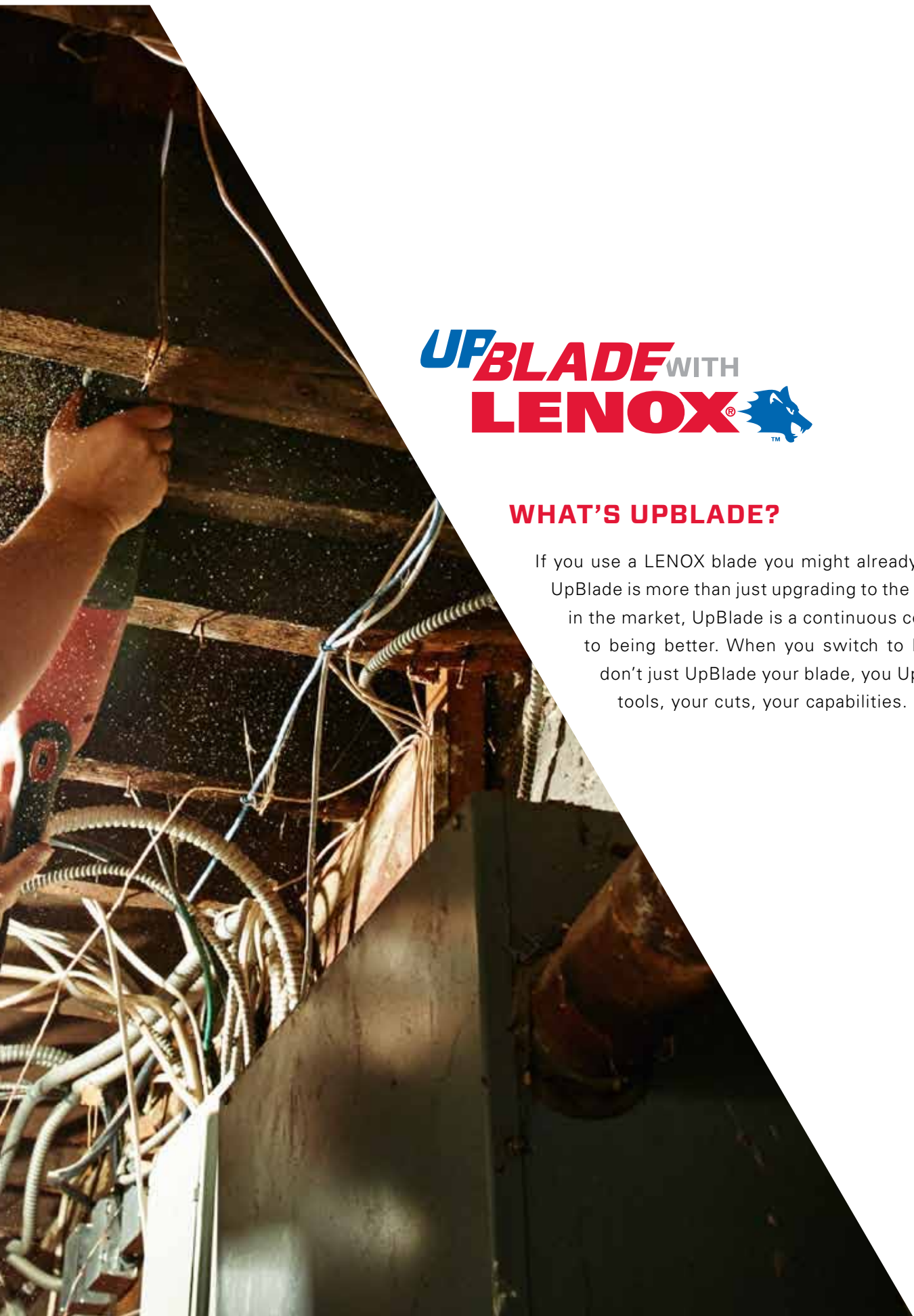

UPBLADE^{WITH} LENOX[®]



WHAT'S UPBLADE?

If you use a LENOX blade you might already know. But UpBlade is more than just upgrading to the best blades in the market, UpBlade is a continuous commitment to being better. When you switch to LENOX you don't just UpBlade your blade, you UpBlade your tools, your cuts, your capabilities.



UPBLADE™

YOUR OPERATIONS

**WHEN CUTTING IS WHAT YOU DO, THE
BLADE YOU CHOOSE BECOMES EVEN
MORE IMPORTANT.**

You're only as efficient as your blade allows you to be. That's why we make sure our band saw blades cut faster and last longer, with the lowest cost per cut—making your operations more competitive. And with our tech reps making sure that our blades are always working at their optimal level, you'll spend more time cutting and less time changing blades. If you don't believe us, talk to your LENOX® representative about taking the UpBlade Challenge.



UPBLADE™ YOUR CAPABILITIES

THERE'S ONLY ONE PART OF YOUR SAW THAT ACTUALLY MAKES THE CUT — THE BLADE.

So you could have the best power tools and machines in the world, but they'll only be as good as the blades you put in them. And even though it might only be part of your job, if your blade isn't making the cut, the whole job pays the price. From our reciprocating saw blades to our carbide band saw blades, our products are always at the forefront of innovation and quality. Our blades are faster and more efficient, allowing you to unlock your full potential.



A large, diagonal photograph of a factory interior, showing industrial machinery and structural elements. The image is partially obscured by a white triangular shape that contains the text.

UPBLADE™ YOUR CRAFT

HAVING THE BEST BLADES IS ONLY PART OF THE EQUATION.

To truly UpBlade, you must also improve yourself. That's why we've developed the LENOX Institute of Technology (LIT).

We provide our Technical Service Reps, distributor partners and consumers with hands-on training by expert instructors who have years of LENOX experience and application knowledge. Because our blades are only as good as the hands that wield them, LIT helps us make sure those hands are amongst the best in the business.

A man with reddish hair, wearing a blue t-shirt, sunglasses, and black gloves, is working on a white car door frame. He is leaning over the frame, which is propped up. In the background, there is a white car with its door open, an American flag on a pole, and a clear blue sky. The scene is outdoors, likely in a car repair shop or a similar setting.

OUR UPBLADE HERITAGE.

The word UpBlade represents a mindset that LENOX® has lived by from day one. For nearly 100 years we've led the industry through many changes and innovations, and our blades have consistently remained on top. You saw this reflected in *HACKMAN*® as he toured the world facing bigger challenges at every stop—returning to us with insights that helped improve our blades' designs. And you see it with the challenges we put before our blades in our One Blade campaign. Challenges such as cutting 8 cars with a single blade. As we push our blades to the limit we UpBlade not only their achievements, but your perception of what one blade is capable of. UpBlade is the reason LENOX makes the best blades in the market. Because we're not satisfied with being the best. We're working hard every day to get even better.



IT WASN'T A GOOD DAY TO LEAVE A WHITE CAR IN OUR PARKING LOT.

We had never cut more than five. But since we are obsessed with relentlessly improving our blades, we wanted to see if we could improve our records as well. And if any blade could do it, it was the LENOX T2™ Demolition. It's engineered to deliver the longest-lasting, fastest-cutting performance in the industry. The result? We ran out of cars before the blade was done cutting. Anyone want to go for nine?

Don't believe us? Go to oneblade.com to see the "making of" video and get a trial blade so you can see for yourself.

UPBLADE WITH
LENOX

LENOX T2™ Demolition Reciprocating Saw Blade / Model 8002

COMMITTED TO BEING BETTER FOR NEARLY 100 YEARS



1915

LENOX® American Saw founded by John Swanson, Carl Ericson, and Carl Davis to manufacture Hacksaw Blades in Springfield, MA

1918

Band Saw Blade production begins

LENOX purchases an electron beam welder and begins manufacturing Bi-metal Band Saw Blades

1965

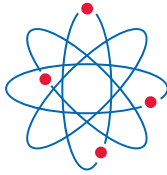

1964
All LENOX operations moved to its current location in East Longmeadow, MA



Hand Tools and Power Tool Accessories.

1977

First Bi-metal Reciprocating Saw Blades

1981

HACKMAN® uses a LENOX Hacksaw Blade to cut his first car in half



Asia Pacific headquarters set up in Shanghai

2006

2005

ARMOR® Band Saw Blades added to the product line

LENOX Gold® Bi-metal Utility Blade and Knife added to the product line

2004

2007

Snips, Bi-metal Drilling Bits and Q Performance Solution™ Band Saw Blades added to the product line

LENOX T2™ Technology recip blades.

2008

Bi-Metal Drilling technology added to product line

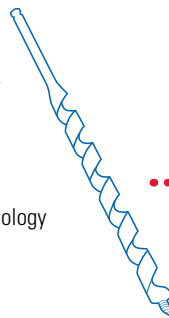

2009

HACKMAN®
WORLD TOUR 2009

Q88™ Band Saw Blade launched in Asia



LENOX's "The Blade in the Plaid Box" airplane flies from Portland, ME to Daytona, FL dropping circulars as it passes over large cities

1921

1952

A second plant was built on Chestnut Street, East Longmeadow, MA

LENOX began manufacturing Band Saw Blades at the East Longmeadow facility

1961



1959

Hole Saws added to product line

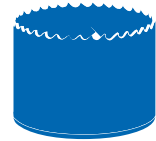

Hacksaw Frames and Carbide Band Saw Blades added to the product line

1985

1986

LENOX VARI-BIT® added to the product line

LENOX enters the Latin American Market

1987

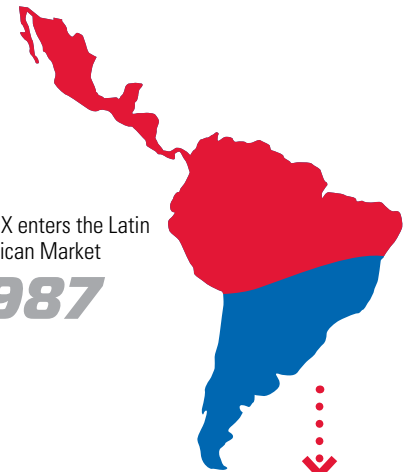

1998

LENOX purchases a local Hand Hacksaw and Utility Knife Blade manufacturer and opened LENOX of Brazil



LENOX becomes the first company in the blade industry to achieve ISO 9001 certification

1996

1991

LENOX Self-Feed Bits added to the product line



2010

2011

Bi-Metal SPEED SLOT® Hole Saw



2015
100 YEAR
ANNIVERSARY





BANDSAW
BLADES

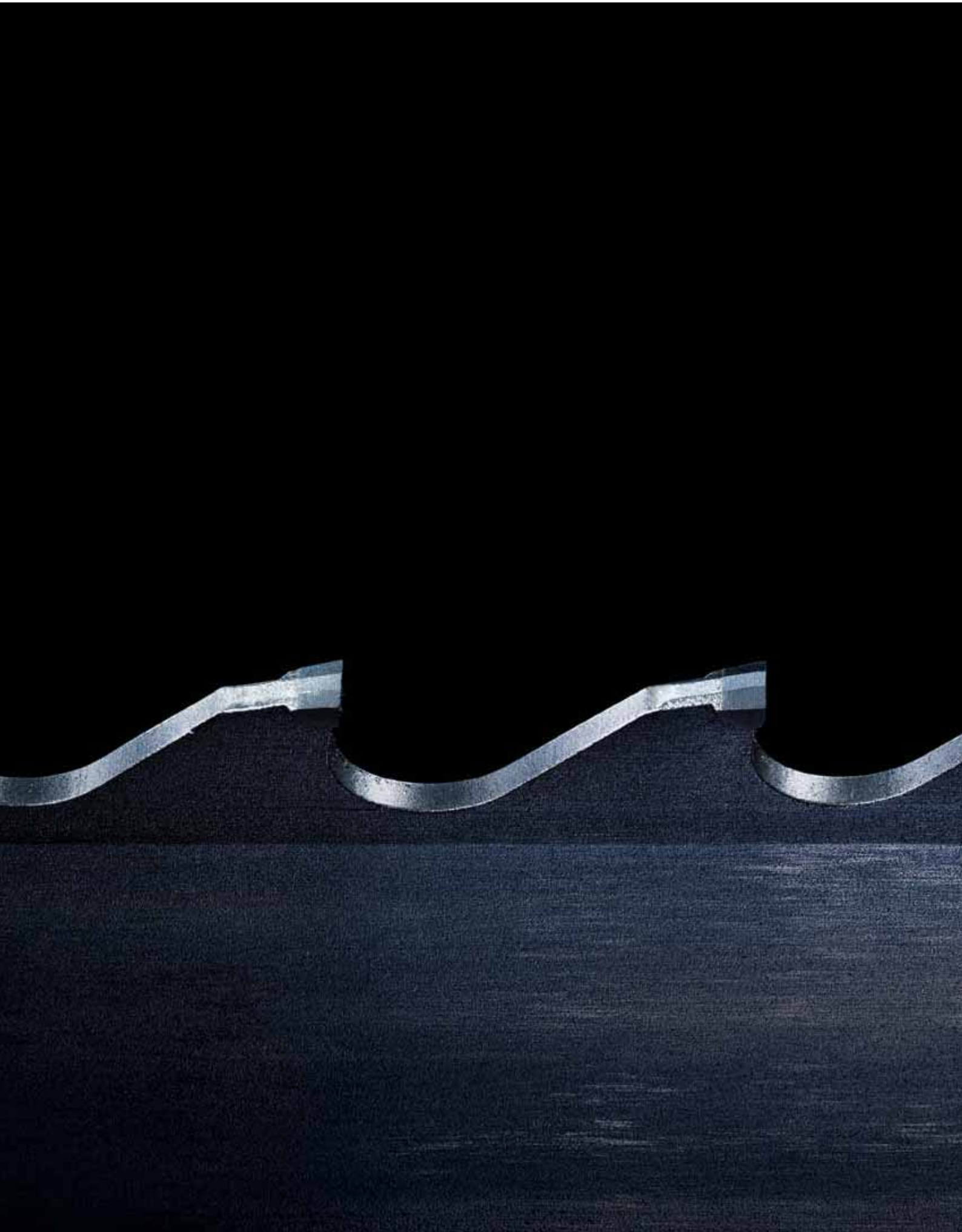

CARBIDE ***BAND SAW BLADES***

Selecting Carbide Blades	14
Tooth Selection	15
<i>ARMOR</i> [®] CT BLACK.....	16
LENOX TNT CT [®] & TRI-TECH [™]	17
TRI-MASTER [®]	18
ALUMINUM MASTER [™] CT & CAST MASTER [™]	19
LENOX HRc [®] & MASTER-GRIT [®]	20
Carbide Speed Chart.....	21





SELECTING CARBIDE TIPPED BAND SAW BLADES

The following information needs to be specified when a band saw blade is ordered:

PRODUCT NAME LENGTH X WIDTH X THICKNESS TEETH PER INCH

For Example: *ARMOR*[®] CT BLACK 16' x 1-1/4" x .042" 2.5/3.4 TPI

STEP #1: ANALYZE THE SAWING APPLICATION

Machine: Determine the band size for the machine (Length x Width x Thickness).

Material: Determine the following for the material to be cut:

- Material Type/Grade
- Size
- Shape

Operation: Is this a production, or general purpose sawing operation?

STEP #2: DETERMINE HIGH PERFORMANCE VS. SPECIAL APPLICATION

Use the charts below.

- Locate the type of material to be cut in the top row.
- Read down the chart to find which blade is recommended.

STEP #3: DETERMINE THE PROPER NUMBER OF TEETH PER INCH (TPI)

Use the Carbide Tooth Selection chart on page 15.

If having difficulty choosing between two pitches, the coarser of the two will generally give better performance.

When compromise is necessary, choose the correct TPI first. A general rule for bundles: Determine the correct TPI for the largest continuous cross section.

STEP #4: CONFIRM THE DESIRED PRODUCT IS AVAILABLE

- Go to the product page for the product you have selected.
- Confirm that product is available in the correct blade width and TPI.

HIGH PERFORMANCE

ALUMINUM/ NON-FERROUS	CARBON STEELS	STRUCTURAL STEELS	ALLOY STEELS	BEARING STEELS	MOLD STEELS	STAINLESS STEELS	TOOL STEELS	TITANIUM ALLOYS	NICKEL-BASED ALLOYS (INCONEL [®])
EASY ← MACHINABILITY → DIFFICULT									
ARMOR[®] CT BLACK Extreme Cutting Rates									
LENOX TNT CT[®]					LENOX TNT CT Extreme Performance on Super Alloys				
TRI-TECH CT[™]			TRI-TECH CT Set Style Blade for Difficult to Cut Metals						
TRI-MASTER[®]			TRI-MASTER Versatile Carbide Tipped Blade						

SPECIAL APPLICATION

WOOD	COMPOSITES	ALUMINUM (INCLUDING ALUM. CASTINGS)	CASE HARDENED MATERIALS (INCLUDING IHCP CYLINDER SHAFTS)	OTHER (COMPOSITES, TIRES, ETC.)
EASY ← MACHINABILITY → DIFFICULT				
CAST MASTER[™] Superior Performance When Sawing Castings			LENOX HRc Carbide Tipped Blade for Case and Through-Hardened Materials	
TRI-MASTER				
MASTER-GRIT[®]		MASTER-GRIT Carbide Grit Edge Blade for Cutting Abrasive and Hardened Materials		

Note: We can provide solutions for many cutting applications not listed here. Please call LENOX Technical Support at 800-642-0010, or go to sawcalc.com.

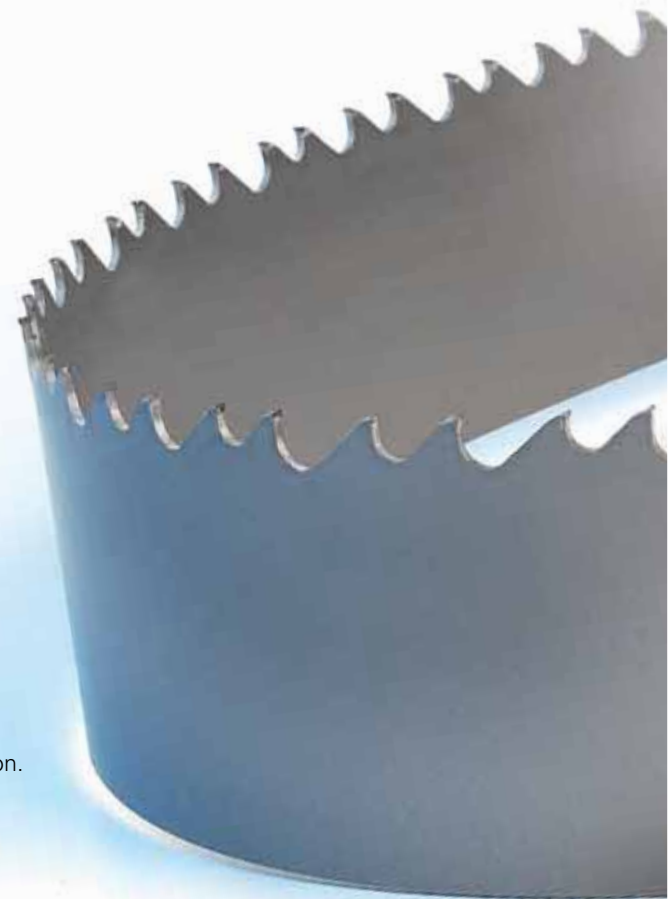

CARBIDE TOOTH SELECTION

VISIT SAWCALC.COM
FOR CUSTOMIZED BAND SAW RECOMMENDATIONS

ARMOR® CT BLACK

		WIDTH OR DIAMETER OF CUT																
INCHES	1	2.5	3	4	5	6	7	8	10	12	13	15	17	20+				
MM	25	60	70	100	120	150	170	200	250	300	330	380	430	500+				
										0.9/1.1 TPI								
								1.4/1.6 TPI										
					1.8/2.0 TPI													
				2.5/3.4 TPI														

LENOX TNT CT®

		WIDTH OR DIAMETER OF CUT																	
INCHES	1	2.5	3	4	5	6	7	8	10	12	13	15	16	17	18	20	34+		
MM	25	60	70	100	120	150	170	200	250	300	330	380	410	430	460	500	865		
										0.9/1.1 TPI									
								1.4/1.8 TPI											
				1.8/2.0 TPI															
			2.5/3.4 TPI																

TRI-TECH CT™

		WIDTH OR DIAMETER OF CUT															
INCHES	1	2.5	3	4	5	6	7	8	10	12	13	15	17	20+			
MM	25	60	70	100	120	150	170	200	250	300	330	380	430	500+			
													0.6/0.8 TPI				
											0.9/1.1 TPI						
								1.4/1.8 TPI									
					1.8/2.0 TPI												
				2.5/3.4 TPI													

TRI-MASTER® • LENOX HRC® • CAST MASTER™

		WIDTH OR DIAMETER OF CUT																
INCHES	1	2.5	3	4	5	6	7	8	10	12	13	15	17	20				
MM	25	60	70	100	120	150	170	200	250	300	330	380	430	500				
										1.2/1.8 TPI								
								1.5/2.3 TPI										
				2/3 TPI														
			3 TPI															
		3/4 TPI																

Note: Aluminum and other soft materials cut on machines with extremely high band speed may change your tooth selection. Please call LENOX Technical Support at 800-642-0010 for more information or go to sawcalc.com.

WHAT IS MERCURIZATION?



This enhanced mechanical design promotes more efficient tooth penetration and chip formation, easily cutting through the work hardened zone. The MERCURIZED symbol denotes any product that can be MERCURIZED. Consult your LENOX Technical Representative to determine if MERCURIZATION will benefit your operation.

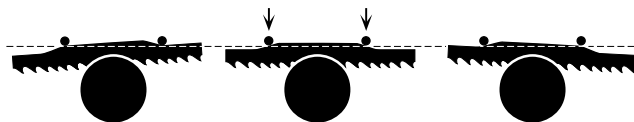



ARMOR® CT BLACK
For Extreme Cutting Rates

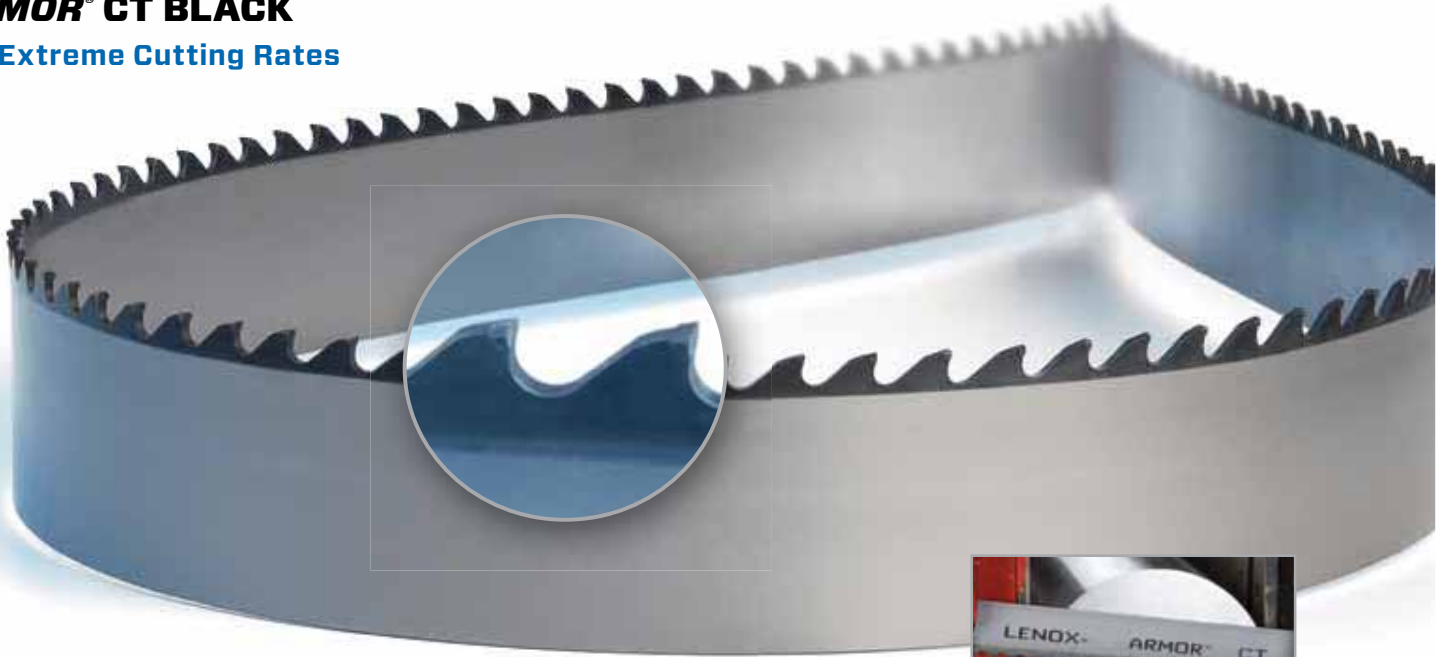

ARMOR COATING PROVIDES FASTER CUTTING AND HIGHER PRODUCTIVITY
Aluminum, Titanium and Nitrogen (AlTiN) combine to form a tough coating that protects each tooth from heat and wear with an armor-like barrier

EXTENDS BLADE LIFE BY PREVENTING HEAT BUILD UP
Improved, thicker coating now forces even more heat into the chips, instead of the blade or workpiece

HIGH PERFORMANCE BACKING STEEL WITH EXCELLENT FATIGUE LIFE
Optimized heat treat and backing steel preparation minimizes premature band breaks

TAILORED TO CUT A WIDE RANGE OF METALS
High quality, micro grained carbide

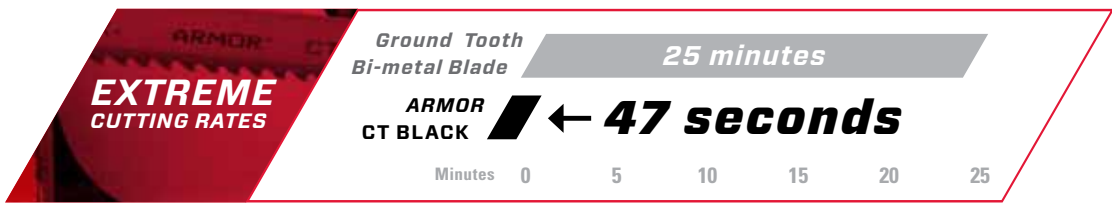

Material: 6-1/2" (165mm) Round 17-4 PH Stainless Steel. Based on internal test results.

WIDTH X THICKNESS		TPI			
IN	MM	0.9/1.1	1.4/1.6	1.8/2.0	2.5/3.4
1-1/4 x .042	34 x 1.07			•	•
1-1/2 x .050	41 x 1.27		•	•	•
2 x .063	54 x 1.60	•	•	•	•
2-5/8 x .063	67 x 1.60	•	•		
3 x .063	80 x 1.60	•			

APPLICATION

- Carbon Steels
- Alloy Steels
- Bearing Steels
- Stainless Steels
- Mold Steels
- Tool Steels
- Titanium Alloys
- Structural Steels



LENOX TNT CT®

Extreme Performance on Super Alloys

HIGH PERFORMANCE CARBIDE AND SPECIAL GROUND TOOTH FORM

Superior wear resistance when sawing difficult to cut materials

HIGH PERFORMANCE BACKING STEEL

Excellent fatigue life

WIDTH X THICKNESS		TPI			
IN	MM	0.9/1.1	1.4/1.8	1.8/2.0	2.5/3.4
1-1/4 x .042	34 x 1.07			•	•
1-1/2 x .050	41 x 1.27	•	•	•	•
2 x .063	54 x 1.60	•	•	•	•
2-5/8 x .063	67 x 1.60	•		•	
3 x .063	80 x 1.60	•			



TRI-TECH CT™

Set Style Carbide Blade for Difficult to Cut Metals

STRAIGHT CUTS. NO PINCHING.

Set style tooth pattern eliminates pinching in high stress metals

Wide kerf clearance enables plunge cutting

PROLONGED BLADE LIFE

High grade carbide tips are precision ground for efficient cutting

High performance backing steel minimizes body breakage

EXTREME VERSATILITY

Cuts a range of materials from high strength steels to Nickel-based alloys

WIDTH X THICKNESS		TPI				
IN	MM	0.6/0.8	0.9/1.1	1.4/1.8	1.8/2.0	2.5/3.4
1-1/4 x .042	34 x 1.07				•	•
1-1/2 x .050	41 x 1.27			•	•	•
2 x .063	54 x 1.60		•	•	•	•
2-5/8 x .063	67 x 1.60	•	•	•		
3 x .063	80 x 1.60	•	•			

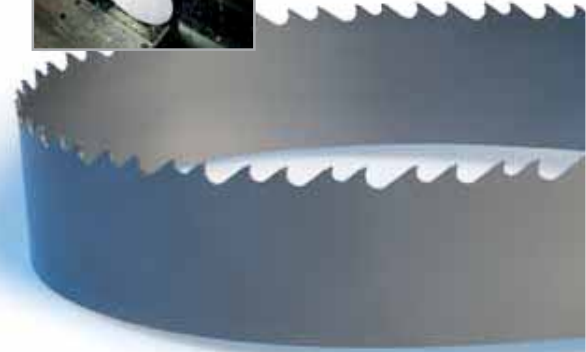

APPLICATION

Nickel-Based Alloys
(Inconel®)
Stainless Steels
Tool Steels

Titanium Alloys
Aluminum/
Non-Ferrous



APPLICATION

Nickel-based Alloys
(Inconel®)
Iron Based Super Alloys
Titanium Alloys
High Chrome Alloys

Stainless Steel
Mold and Tool Steels
Aluminum/
Non-Ferrous





TRI-MASTER®

Versatile Carbide Tipped Blade

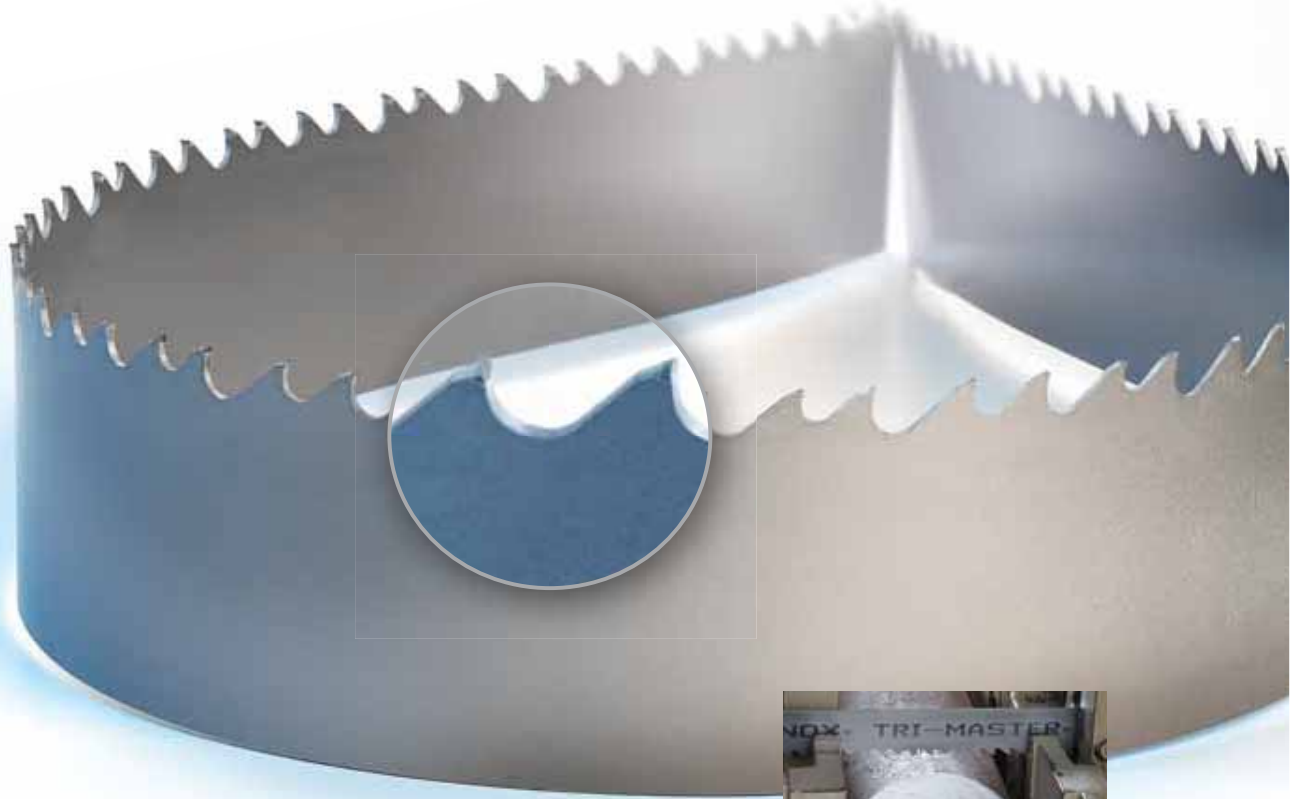

PRECISION TRIPLE CHIP GRIND

Smooth cuts, excellent finish

HIGH PERFORMANCE BACKING STEEL

Excellent fatigue life

GENERAL PURPOSE BLADE

Perfect for cutting of a wide variety of materials

WIDTH X THICKNESS		TPI				STANDARD TPI
IN	MM	1.2/1.8	1.5/2.3	2/3	3/4	3
3/8 x .032	9.5 x 0.80				•	•
1/2 x .025	12.7 x 0.64					•
3/4 x .035	19 x 0.90					•
1 x .035	27 x 0.90			•	•	•
1-1/4 x .042	34 x 1.07		•	•	•	•
1-1/2 x .050	41 x 1.27	•		•	•	•
2 x .063	54 x 1.60	•		•		
2-5/8 x .063	67 x 1.60	•				
3 x .063	80 x 1.60	•				

APPLICATION

Aluminum/ Non-Ferrous	Mold Steels
Carbon Steels	Tool Steels
Alloy Steels	Wood
Bearing Steels	Titanium Alloys
Stainless Steels	Nickel-Based Alloys (Inconel®)



CAST MASTER™

Superior Performance When Sawing Castings

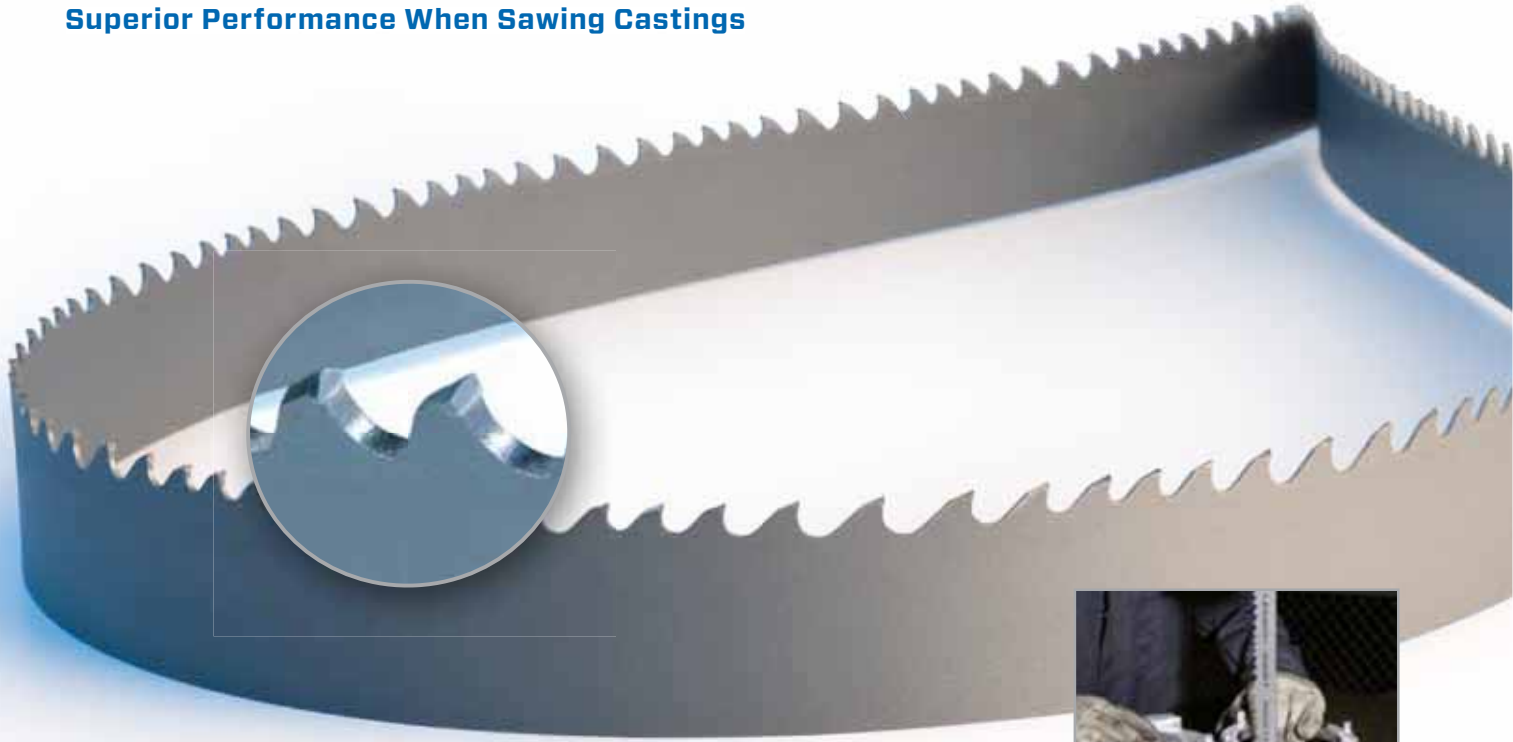

EXCEPTIONAL BLADE LIFE IN HAND FED FOUNDRY APPLICATIONS

Sub-micron grade carbide designed for cutting aluminum and non-ferrous parts
Precision grind on the rake face prevents material build up on the tooth edge

CUTS PARTS FREELY WITH LIMITED FEED PRESSURE

Optimized rake angle and narrow kerf enable high speed cutting without pulling the part
Multi-chip tooth design reduces cutting forces and limits vibration

HIGH ALLOY BACKING STEEL INCREASES FATIGUE LIFE

Advanced backing steel preparation minimizes band breaks

WIDTH X THICKNESS		TPI			
IN	MM	2	2/3	3	3/4
1/2 x .025	12.7 x 0.64			•	
3/4 x .035	19 x 0.90			•*	•
1 x .035	27 x 0.90		•	•*	•
1-1/4 x .042	34 x 1.07	•	•	•	•
1-1/2 x .050	41 x 1.27		•		

• Multi-chip Design
* Set Style (Cast Master SST)

APPLICATION

Aluminum/ Non-Ferrous Castings	Wood Composites
Gates & Risers	





LENOX HRC®

Carbide Tipped Blade for Case and Through-Hardened Materials

HIGH QUALITY, MICRO-GRAINED CARBIDE

Outstanding durability

STRONG TOOTH DESIGN

Superior edge strength and strip resistance

NEW HIGH PERFORMANCE BACKING STEEL

Excellent fatigue life

REPLACES ABRASIVE CUT OFF OPERATIONS

WIDTH X THICKNESS		VARI-TOOTH® TPI		STANDARD TPI
IN	MM	2/3	3/4	3
1 x .035	27 x 0.90			•
1-1/4 x .042	34 x 1.07		•	•
1-1/2 x .050	41 x 1.27		•	
2 x .063	54 x 1.60	•		

MASTER-GRIT®

Carbide Grit Edge Blade for Cutting Abrasive and Hardened Materials

TUNGSTEN CARBIDE PARTICLE GRIT

Metallurgically bonded edge

GULLETED

For applications greater than 1/4" (6.4mm) in cross-section

CONTINUOUS

For applications less than 1/4" (6.4mm) in cross-section

WIDTH X THICKNESS		GRIT EDGE PREPARATION				
		GULLETED			CONTINUOUS	
IN	MM	MED	MED COARSE	COARSE	MED	COARSE
1/4 x .020	6.4 x 0.50				•	
3/8 x .025	9.5 x 0.64	•	•			
1/2 x .025	12.7 x 0.64	•	•		•	
3/4 x .032	19 x 0.80		•	•		
1 x .035	27 x 0.90		•	•	•	•
1-1/4 x .042	34 x 1.07			•		



APPLICATION

- Carbon Steels
- Stainless Steels
- Case Hardened Materials



APPLICATION

- Case Hardened Materials
- Other:
 - Fiberglass,
 - Steel Belted Radial Tires,
 - Composites

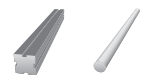

CARBIDE SPEED CHART

VISIT SAWCALC.COM
FOR CUSTOMIZED BAND SAW RECOMMENDATIONS

FPM = Feet Per Minute | MPM = Meters Per Minute *For metal cutting saws run between 275 and 350 FPM. **Typically for hardened and case hardened carbon steels up to 61 Rc.

MATERIALS		ARMOR [®] CT BLACK		LENOX TNT CT		TRI-TECH™		TRI-MASTER [®]		CAST MASTER™		LENOX HRC [®]	
TYPE	GRADE	FPM	MPM	FPM	MPM	FPM	MPM	FPM	MPM	FPM	MPM	FPM	MPM
Aluminum Alloys	2024, 5052, 6061, 7075			3,500-8,500*	1000-2600	3,500-8,500	1,000-2,600	3,500-8,500*	1000-2600	3,500-8,500*	1000-2600		
Copper Alloys	CDA 220 CDA 360 Cu Ni (30%) Be Cu			240 300 220 180	75 90 65 55	240 300 220 180	73 91 67 55	210 295 200 160	65 90 60 50	210 295 200 160	65 90 60 50	280	85
Bronze Alloys	AMPCO 18 AMPCO 21 AMPCO 25 Leaded Tin Bronze Al Bronze 865 Mn Bronze 932 937			205 180 115 300 200 220 300 300	60 55 35 90 60 65 90 90	205 180 115 300 180 220 300 300	62 55 35 91 55 67 91 91	180 160 110 290 150 215 280 250	55 50 35 90 45 65 85 75	180 160 110 290 150 215 280 250	55 50 35 90 45 65 85 75		
Brass Alloys	Cartridge Brass Red Brass (85%) Naval Brass			260 230	80 70	240 230	73 70	220 200	65 60			220 200	65 60
Leaded, Free Machining Low Carbon Steels	1145 1215 12L14	370 425 450	115 130 135			290 325 350	88 99 107	290 325 350	90 100 105				
Structural Steel	A36	350	105										
Low Carbon Steels	1008, 1018 1030	310 290	95 90			250 240	76 73	250 240	75 75			270** 250**	80 75
Medium Carbon Steels	1035 1045	285 275	85 85			230 220	70 67	230 220	70 65			240** 230**	75 70
High Carbon Steels	1060 1080 1095	260 250 240	80 75 75									200** 195** 185**	60 60 55
Mn Steels	1541 1524	260 240	80 75										
Cr-Mo Steels	4140 41L50 4150H	300 310 290	90 95 90			220 250	67 76						
Cr Alloy Steels	6150 52100 5160	315 300 315	95 90 95			190 190	58 58						
Ni-Cr-Mo Steels	4340 8620 8640 E9310	300 310 305 315	90 95 95 95			190 190	58 58						
Low Alloy Tool Steel	L-6	300	90	240	75	240	73	190	60				
Water-Hardening Tool Steel	W-1	300	90	240	65	220	67	175	55				
Cold-Work Tool Steel	D-2	240	75	210	65	210	64	170	50				
Air-Hardening Tool Steels	A-2 A-6 A-10	270 240 190	80 75 60	230 220 160	70 65 50	230 220 160	70 67 49	185 175 130	55 55 40				
Hot Work Tool Steels	H-13 H-25	240 180	75 55	220 150	55 45	220 150	67 46	175 120	55 35				
Oil-Hardening Tool Steels	O-1 O-2	260 240	80 75	240 220	75 65	240 220	73 67	190 175	60 55				
High Speed Tool Steels	M-2, M-10 M-4, M-42 T-1 T-15	140 130 120 100	45 40 35 30	110 105 100 80	35 30 30 25	110 105 100 80	34 32 30 24	90 85 80 65	25 25 25 20				
Mold Steels	P-3 P-20	300 280	90 85	200 160	60 50	200 160	61 49	160 130	50 40				
Shock Resistant Tool Steels	S-1 S-5, S-7	220 200	65 60										
Stainless Steels	304 316 410, 420 440A 440C	260 240 290 250 240	80 75 90 75 75	220 180 250 200 200	65 55 75 60 60	190 180 250 200 200	58 55 76 61 61	155 125 175 140 140	45 40 55 45 45			220 180 250 200 200	65 55 75 60 60
Precipitation Hardening Stainless Steels	17-4 PH 15-5 PH	300 300	90 90	160 140	50 45	160 160	49 49	110 100	35 30			160 140	50 45
Free Machining Stainless Steels	420F 301	340 320	105 100	270 230	80 70	270 230	82 70	190 160	60 50			270 230	80 70
Nickel Alloys	Monel [®] K-500 Duranickel [®] 301			90 80	25 25	90 80	27 24	90 80	25 25				
Iron-Based Super Alloys	A286, Incoloy [®] 825 Incoloy 600 Pyromet [®] X-15			80 75 90	25 25 25	105 85 90	32 26 27	80 75 90	25 25 25				
Nickel-Based Alloys	Inconel [®] 600, Inconel 718 Nimonic [®] 90 NI-SPAN-C [®] 902, RENE [®] 41 Inconel [®] 625 Hastalloy B, Waspalloy Nimonic [®] 75, RENE [®] 88			85 85 115 75 75	25 25 35 25 25	105 100 105 105 100 105	32 30 32 32 30 32	85 85 115 75 75	25 25 35 25 25				
Titanium Alloys	CP Titanium Ti-6Al-4V	230 230	70 70	180 180	55 55	180 180	55 55	150 150	45 45				
Cast Irons	A536 (60-40-18) A536 (120-90-02) A48 (Class 20) A48 (Class 40) A48 (Class 60)	360 175 250 160 115	110 55 75 50 35										



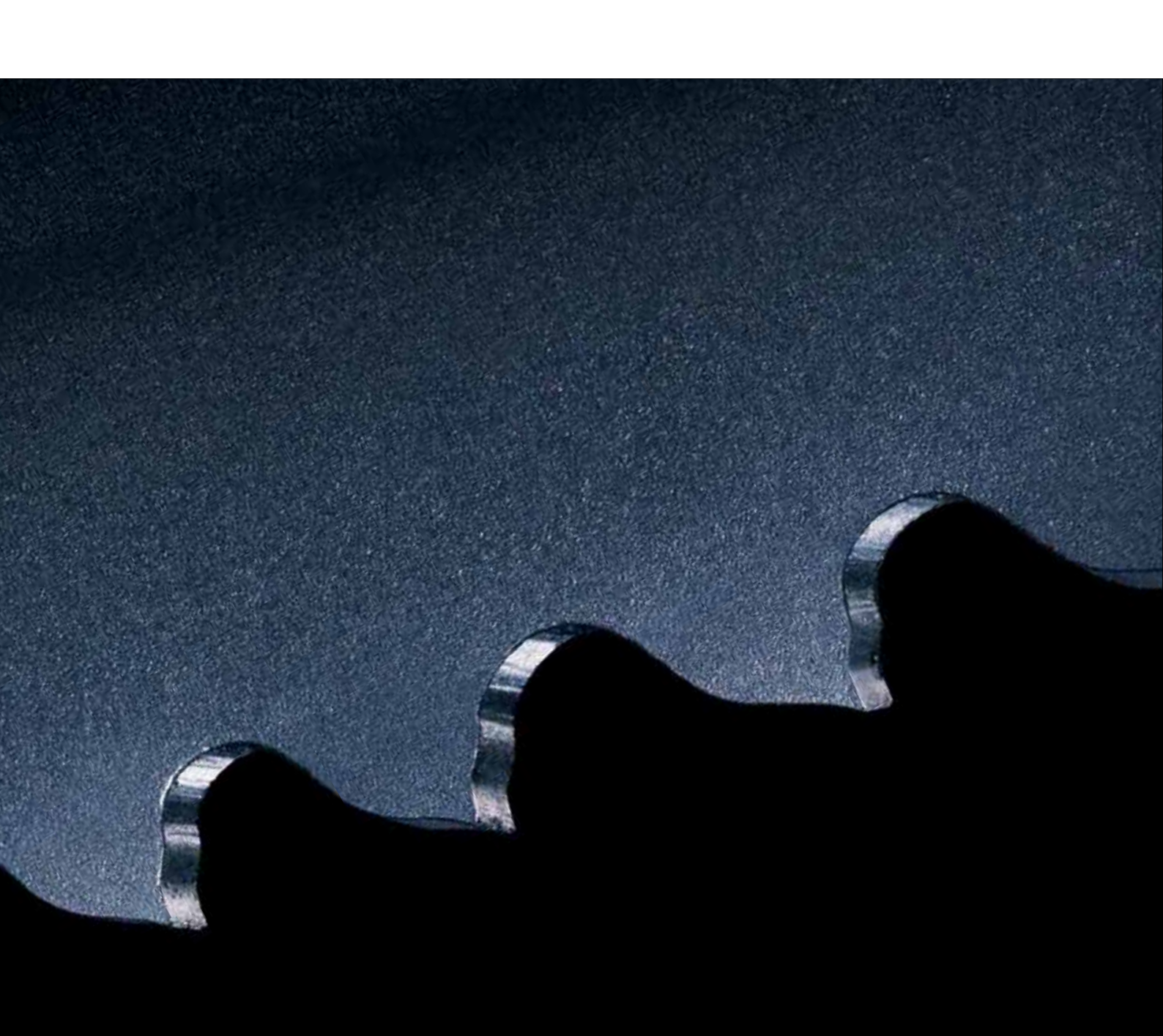

BI-METAL BAND SAW BLADES

Selecting Bi-metal Blades	24
Tooth Selection	25
<i>QXP™</i>	26
<i>CONTESTOR GT®</i>	27
<i>ARMOR RX®+</i>	28
<i>LENOX RX®+</i>	29
<i>LENOX CLASSIC PRO™</i>	30
<i>LENOX CLASSIC® & DIEMASTER 2®</i>	31
Bi-metal Speed Chart	32
Blade Break-In.....	33



SELECTING BI-METAL BAND SAW BLADES

The following information needs to be specified when a band saw blade is ordered:

PRODUCT NAME LENGTH X WIDTH X THICKNESS TEETH PER INCH

For Example: *Contestor GT*® 16' x 1-1/4" x .042" 3/4 TPI

STEP #1: ANALYZE THE SAWING APPLICATION

Machine: Determine the band size for the machine (Length x Width x Thickness).

Material: Determine the following for the material to be cut:

- Material Type/Grade
- Size
- Shape
- Will material be stacked/bundled, or cut one at a time?

Operation: Is this a production, or general purpose sawing operation?

STEP #2: DETERMINE THE BEST PRODUCT FOR THE APPLICATION

Use the charts below.

- Locate the type of material to be cut in the top row.
- Read down the chart to find which blade is recommended.

STEP #3: DETERMINE THE PROPER NUMBER OF TEETH PER INCH (TPI)

- Use the Bi-metal Tooth Selection chart on page 25.

STEP #4: CONFIRM THE DESIRED PRODUCT IS AVAILABLE

- Go to the product page for the product you have selected.
- Confirm that product is available in the correct blade width and TPI.

FOR ASSISTANCE, CONTACT LENOX TECHNICAL SUPPORT 800-642-0010.



PRODUCTION SAWING

ALUMINUM NON-FERROUS	CARBON STEELS	STRUCTURAL STEELS	ALLOY STEELS	BEARING STEELS	MOLD STEELS	TOOL STEELS	STAINLESS STEELS	TITANIUM ALLOYS	NICKEL-BASED ALLOYS (INCONEL®)	
EASY ←			MACHINABILITY				→ DIFFICULT			
<i>QXP™</i>		<i>QXP</i> Long Life. Fast Cutting					<i>CONTESTOR GT®</i> Long Life. Straight Cuts			
<i>ARMOR® Rx®+</i> Long Life. Structurals/Bundles										
<i>LENOX Rx®+</i> Structurals/Bundles										
<i>CLASSIC PRO™</i> Long Life. Extremely Versatile				<i>CLASSIC PRO</i>						

GENERAL PURPOSE

<i>LENOX CLASSIC®</i> 3/4" and Wider Blades	<i>LENOX CLASSIC</i>
<i>DIEMASTER 2®</i> 1/2" and Narrower Blades	<i>DIEMASTER 2</i>

Note: We can provide solutions for many cutting applications not listed here. Please call LENOX Technical Support at 800-642-0010, or go to sawcalc.com.

BI-METAL TOOTH SELECTION

VISIT SAWCALC.COM
FOR CUSTOMIZED BAND SAW RECOMMENDATIONS

1. Determine the size and shape of material to be cut.
2. Identify the chart to be used (square solids, round solids, or tubing/structurals).
3. Read teeth per inch next to material size.

SQUARE/RECTANGLE SOLID Locate width of cut (W)

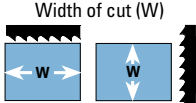
		WIDTH OF CUT																			
IN	.1	.2	.3	.4	.5	.6	.7	.8	.9	1	2	5	10	15	20	25	30	35	40	45	50
MM	2.5	5	7.5	10	12.5	15	17.5	20	22.5	25	50	125	250	375	500	625	750	875	1000	1125	1250
TPI	14/18	10/14	8/12	6/10	6/8 5/8		4/6	3/4	2/3	1.5/2.0 1.4/2.0		1.0/1.3			0.7/1.0						

ROUND SOLID Locate diameter of cut (D)

		DIAMETER OF CUT																			
IN	.1	.2	.3	.4	.5	.6	.7	.8	.9	1	2	5	10	15	20	25	30	35	40	45	50
MM	2.5	5	7.5	10	12.5	15	17.5	20	22.5	25	50	125	250	375	500	625	750	875	1000	1125	1250
TPI	14/18		10/14	8/12	6/10	6/8 5/8		4/6	3/4	2/3	1.5/2.0 1.4/2.0		1.0/1.3			0.7/1.0					

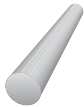
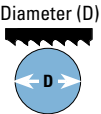
TUBING/PIPE/STRUCTURALS Locate wall thickness (T)

BUNDLED/STACKED MATERIALS:

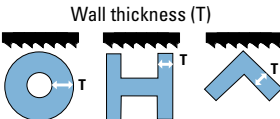
To select the proper number of teeth per inch (TPI) for bundled or stacked materials, find the recommended TPI for a single piece and choose one pitch coarser to cut the bundle

		WALL THICKNESS																		
IN	.05	.10	.15	.20	.25	.30	.40	.50	.60	.70	.80	.90	1	1.5	2					
MM	1.25	2.5	3.75	5	6.25	7.5	10	12.5	15	17.5	20	22.5	25	37.5	50					
TPI	14/18	10/14	8/12	6/10	6/8 5/8		4/6		3/4			2/3								

WHAT IS MERCURIZATION?



This enhanced mechanical design promotes more efficient tooth penetration and chip formation, easily cutting through the work hardened zone. The MERCURIZED symbol denotes any product that can be MERCURIZED. Consult your LENOX Technical Representative to determine if MERCURIZATION will benefit your operation.

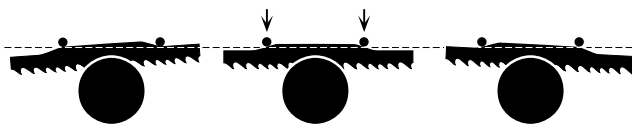



QXP™

Long Blade Life At High Cutting Rates

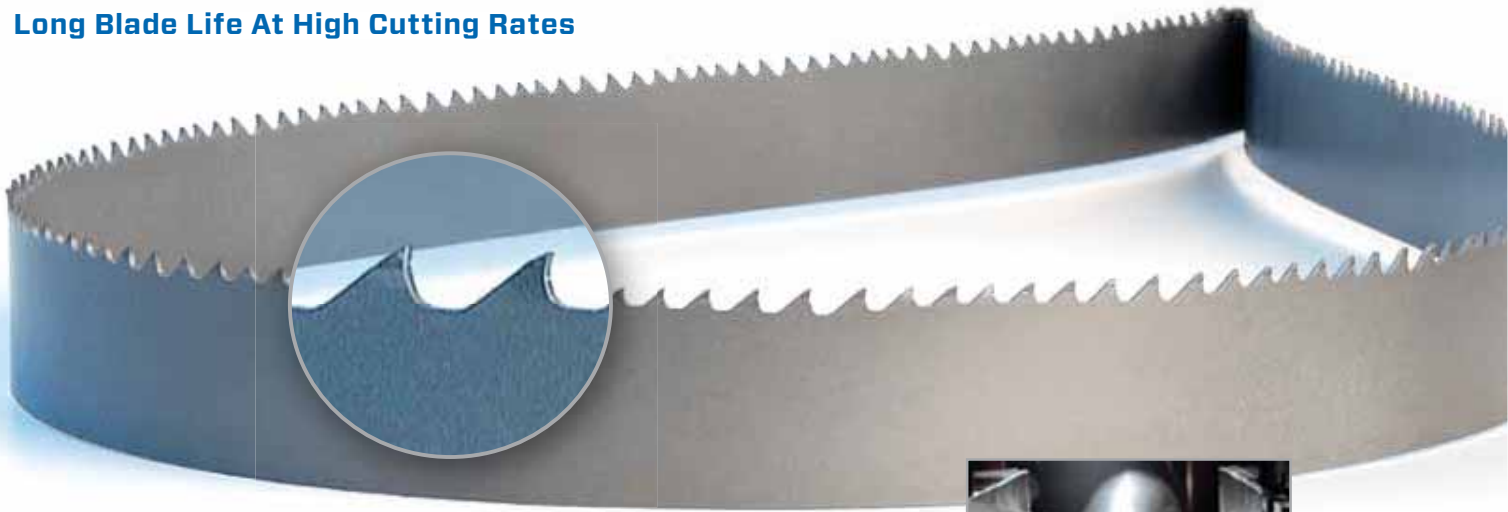

LONG LIFE. FAST CUTTING

Solids of mild to moderate machinability
 Proprietary backing steel preparation provides increased fatigue life

PENETRATES WITH LESS FEED FORCE

Extreme positive rake tooth form

INCREASED CUTTING RATES

Deep gullet design

WIDTH X THICKNESS		TPI					
IN	MM	1.0/1.3	1.5/2.0	2/3	3/4	4/6	5/8
3/4 x .035	19 x 0.90					◆	
1 x .035	27 x 0.90			◆	◆	◆	◆
1-1/4 x .042	34 x 1.07		◆	◆	◆	◆	◆
1-1/2 x .050	41 x 1.27		◆	◆	◆	◆	
2 x .063	54 x 1.60	◆	◆	◆	◆	◆	
2-5/8 x .063	67 x 1.60	◆	◆	◆			
3 x .063	80 x 1.60	◆					

APPLICATION

Aluminum/ Non-Ferrous	Bearing Steels
Carbon Steels	Mold Steels
Alloy Steels	Stainless Steels
	Tool Steels

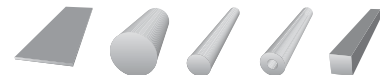

◆ LENOX LXP® spec

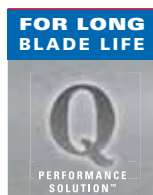

**LONG LIFE. SMOOTH CUTTING.
 BLADE AFTER BLADE. GUARANTEED.***

*The recommended Q Performance Solution Blade will outperform your current product or your money back. Contact your LENOX Technical Sales Representative for more information.

CONTESTOR GT®

High Performance Sawing

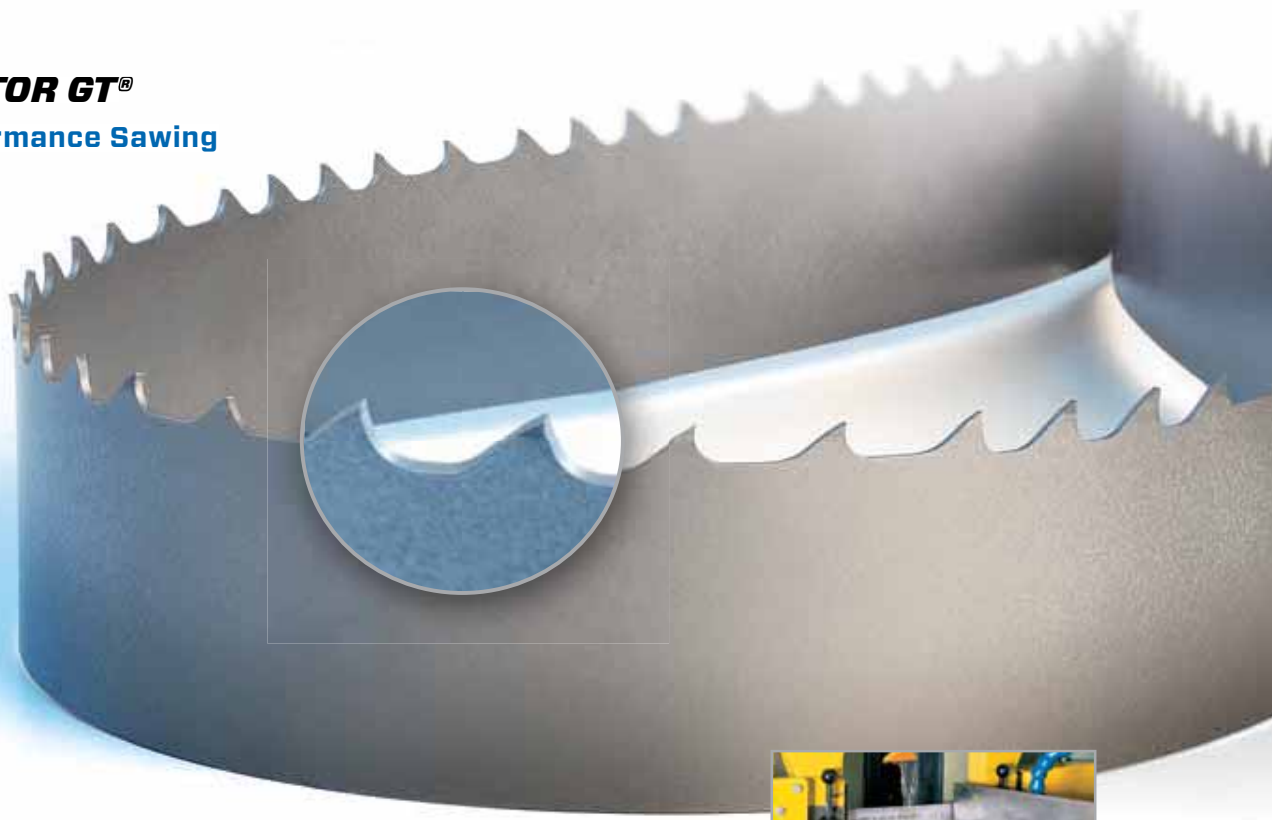

STRAIGHTER CUTS ON LARGER, DIFFICULT TO CUT MATERIALS

Unique gullet design for increased beam strength

OPTIMUM CHIP FORMATION IN WORK HARDENING ALLOYS

Precision ground teeth—smoother tooth face and gullet surfaces

Patented special set and tooth profile

IMPROVED LIFE WITH OPTIONAL M-51 EDGE MATERIAL

Increased heat and wear resistance

Available as listed below

WIDTH X THICKNESS		TPI					
IN	MM	0.7/1.0	1.0/1.3	1.4/2.0	2/3	3/4	4/6
1 x .035	27 x 0.90				•	•	•
1-1/4 x .042	34 x 1.07			◆	◆	◆	◆
1-1/2 x .050	41 x 1.27			◆	◆■	◆■	◆
2 x .050	54 x 1.27		◆	◆	◆		
2 x .063	54 x 1.60	◆	◆	◆	◆■	◆	
2-5/8 x .063	67 x 1.60	◆	◆■	◆■	◆		
3 x .063	80 x 1.60	◆	◆	◆			

- = Milled tooth
- ◆ = Ground tooth
- = Available with M-51 edge



APPLICATION

Mold Steels	Titanium Alloys
Stainless Steels	Nickel-Based Alloys (Inconel®)
Tool Steels	





ARMOR RX⁺

Engineered for Long Life



ALTiN COATING FOR PRODUCTIVITY AND LONG BLADE LIFE

Aluminum, Titanium, and Nitrogen combine to form a coating that is hard and tough, protecting each tooth from heat and wear with an armor-like barrier

UNIQUE, PATENTED TOOTH PROFILE

Special, reinforced tooth design for reduced tooth strippage at higher feed rates

Minimized harmonics and vibrations

Quiet cutting

HIGH PERFORMANCE BACKING STEEL

For longer fatigue life



WIDTH X THICKNESS		TPI		
IN	MM	2/3	3/4	4/6
1-1/4 x .042	34 x 1.07		♦†	♦
1-1/2 x .050	41 x 1.27	♦	♦†	♦†
2 x .063	54 x 1.60	♦	♦†	

† = Extra heavy set available to prevent blade pinching

APPLICATION

Carbon Steels
Structural Steels

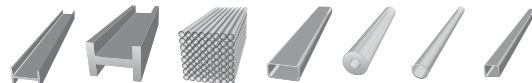

LENOX *RX*⁺

Engineered to Cut structurals, tubing and bundles

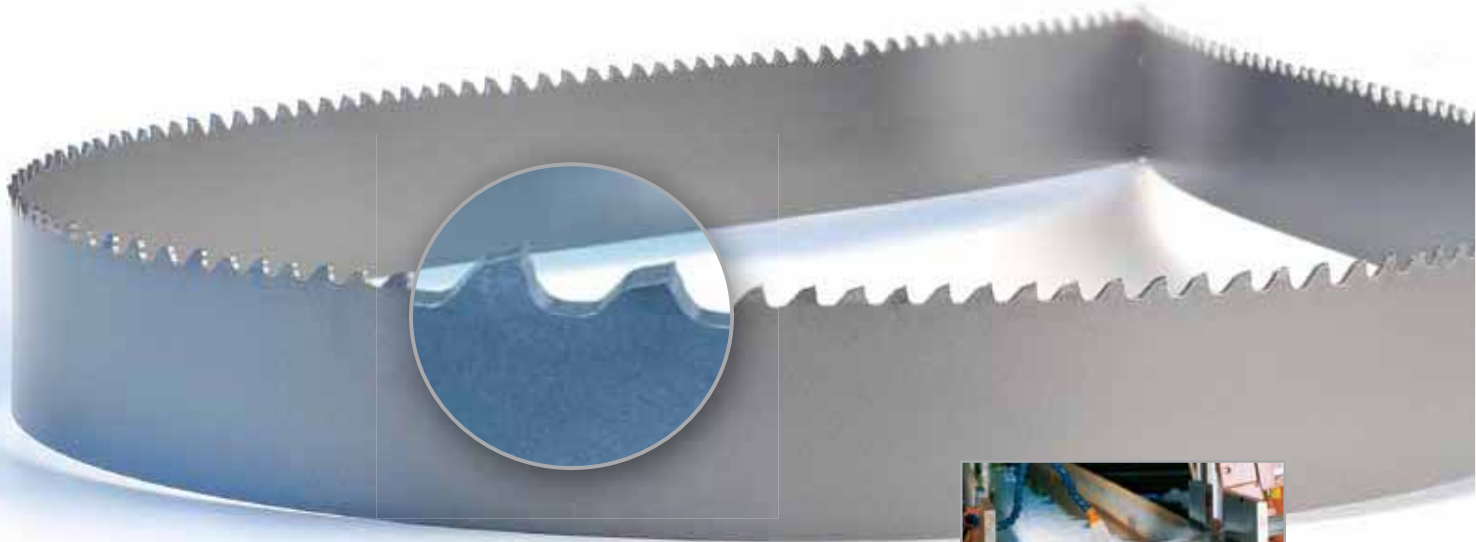

LONG BLADE LIFE AND EXTREME DURABILITY

Patented tooth profile resists tooth strippage, even at higher feed rates

QUIET CUTTING, REDUCED VIBRATION

Optimized tooth pitch/set sequence

WIDTH X THICKNESS		TPI				
IN	MM	2/3	3/4	4/6	5/8	10/14
5/8 x .032	16 x 0.80					*
3/4 x .035	19 x 0.90			♦	♦	
1 x .035	27 x 0.90	♦	♦	♦	♦	
1-1/4 x .042	34 x 1.07	♦†	♦†	♦†	♦	
1-1/2 x .050	41 x 1.27	♦†	♦†	♦†	♦	
2 x .050	54 x 1.27	♦	♦†	♦	♦	
2 x .063	54 x 1.60	♦†	♦†	♦		
2-5/8 x .063	67 x 1.60	♦†	♦†	♦		

*= Matrix edge

†= Extra heavy set available to prevent blade pinching

APPLICATION

Carbon Steels
Structural Steels





LENOX CLASSIC PRO™

The Ultimate Multi-Purpose Blade for Production Cutting

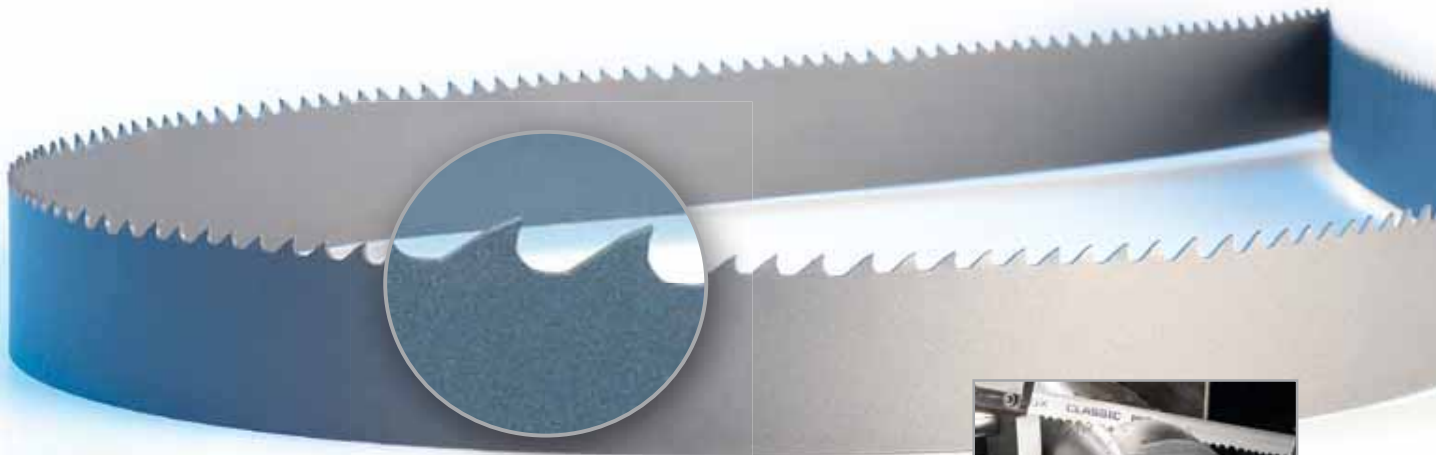

EXCEPTIONAL BLADE LIFE

Proprietary backing steel preparation increases fatigue life and minimizes band breaks
Robust M-42 high speed steel edge provides superior heat and wear resistance

EXTREMELY VERSATILE

Cuts a wide range of metals from low carbon steels to higher strength alloys
Advanced design enables production cutting of solids and structurals
Positive rake angle improves tooth penetration on saws with limited feed force

CONSISTENT PERFORMANCE CUT AFTER CUT

Unique tooth geometry and set minimizes noise and vibration from the very first cut
Smooth, straight cuts when cutting multiple pieces or wide cross sections

WIDTH X THICKNESS		TPI				
IN	MM	1.4/2.0	2/3	3/4	4/6	5/8
1 x .035	27 x 0.90		♦	♦†	♦	♦
1-1/4 x .042	34 x 1.07	♦	♦	♦†	♦	♦
1-1/2 x .050	41 x 1.27	♦	♦	♦†	♦	♦
2 x .050	54 x 1.27		♦	♦	♦	
2 x .063	54 x 1.60	♦	♦†	♦†	♦	
2-5/8 x .063	67 x 1.60	♦	♦†	♦†		

APPLICATION

Carbon Steels Stainless Steels
Alloy Steels Tool Steels
Mold Steels Structural Steels
Aluminum/Non Ferrous

† = Extra heavy set available to prevent blade pinching



LENOX CLASSIC®

The Ultimate Multi-Purpose Blade

DESIGNED FOR LONG LIFE IN GENERAL PURPOSE

CUTTING APPLICATIONS

Patented **TUFFTOOTH™** design reduces tooth strippage



M-42 high speed steel edge for excellent heat and wear resistance



WIDTH X THICKNESS		TOOTH FORM								
		TUFF TOOTH™ TPI			VARI-TOOTH™ TPI			WAVY TPI		HOOK TPI
IN	MM	4/6	6/8	5/8	6/10	8/12	10/14	14	18	3
3/4 x .035	19 x 0.90	◆	◆	◆	◆	◆	◆	◆	◆	◆
1 x .035	27 x 0.90	◆	◆	◆	◆	◆	◆		◆	
1-1/4 x .042	34 x 1.07	◆	◆	◆	◆	◆				

APPLICATION

Aluminum/ Non-Ferrous	Alloy Steels
Carbon Steels	Stainless Steels
Structural Steels	Tool Steels



DIEMASTER 2®

Engineered for Contour Cutting

FASTER CUTTING WITH M-42 HIGH SPEED STEEL TOOTH EDGE

Runs at twice the speed of carbon blades for faster, easier cutting

LONGER BLADE LIFE

Lasts 10 times longer than carbon blades

FOR GENERAL PURPOSE HAND-FED APPLICATIONS

Tool and die shops, machine shops, maintenance facilities



WIDTH X THICKNESS		TOOTH FORM										
		VARI-TOOTH™ TPI				STANDARD TPI				HOOK TPI		
IN	MM	6/10	8/12	10/14	14/18	10	14	18	24	3	4	6
1/4 x .025	6.4 x 0.64			◆	◆							◆
1/4 x .035	6.4 x 0.90			◆								◆
3/8 x .025	9.5 x 0.64			◆	◆							
3/8 x .035	9.5 x 0.90					◆					◆	◆
1/2 x .020	12.7 x 0.50			*	*		*	*	*			
1/2 x .025	12.7 x 0.64	◆	◆	◆	◆		◆	◆			◆	◆
1/2 x .035	12.7 x 0.90					◆	◆			◆	◆	◆

APPLICATION

Aluminum/ Non-Ferrous	Alloy Steels
Carbon Steels	Stainless Steels
Structural Steels	Tool Steels
	Wood



* = Matrix edge



BI-METAL SPEED CHART

VISIT SAWCALC.COM
FOR CUSTOMIZED BAND SAW RECOMMENDATIONS

	MATERIALS		BAND SPEED	
	TYPE	GRADE	FEET/ MIN	METER/ MIN
ALUMINUM / NON-FERROUS	Aluminum Alloys	2024, 5052, 6061, 7075	300+	85+
	Copper Alloys	CDA 220	210	65
		CDA 360	295	90
		Cu Ni (30%)	200	60
		Be Cu	160	50
Bronze Alloys	AMPCO 18	180	55	
	AMPCO 21	160	50	
	AMPCO 25	110	35	
	Leaded Tin Bronze	290	90	
	Al Bronze 865	150	45	
	Mn Bronze	215	65	
	932	280	85	
937	250	75		
Brass Alloys	Cartridge Brass, Red Brass (85%)	220	65	
	Naval Brass	200	60	
CARBON STEELS	Leaded, Free Machining Low Carbon Steels	1145	270	80
		1215	325	100
		12L14	350	105
		1008, 1018	270	80
	Low Carbon Steels	1030	250	75
		1035	240	75
	Medium Carbon Steels	1045	230	70
1060		200	60	
High Carbon Steels	1080	195	60	
	1095	185	55	
	1095	185	55	
STRUCTURAL STEEL	Structural Steel	A36	250	75
ALLOY STEEL	Mn Steels	1541	200	60
		1524	170	50
	Cr-Mo Steels	4140	225	70
		41L50	235	70
		4150H	200	60
	Cr Alloy Steels	6150	190	60
		5160	195	60
	Ni-Cr-Mo Steels	4340	195	60
8620		215	65	
8640		185	55	
E9310		160	50	
BEARING STEEL	Cr Alloy Steels	52100	160	50
MOLD STEEL	Mold Steels	P-3	180	55
		P-20	165	50
STAINLESS STEEL	Stainless Steels	304	115	35
		316	90	25
		410, 420	135	40
		440A	80	25
		440C	70	20
	Precipitation Hardening Stainless Steels	17-4 PH	70	20
		15-5 PH	70	20
Free Machining Stainless Steels	420F	150	45	
	301	125	40	
TOOL STEEL	Low Alloy Tool Steel	L-6	145	45
	Water-Hardening Tool Steel	W-1	145	45
	Cold-Work Tool Steel	D-2	90	25
	Air-Hardening Tool Steels	A-2	150	45
		A-6	135	40
		A-10	100	30
	Hot Work Tool Steels	H-13	140	40
		H-25	90	25
	Oil-Hardening Tool Steels	O-1	140	40
		O-2	135	40
	High Speed Tool Steels	M-2, M-10	105	30
		M-4, M-42	95	30
		T-1	90	25
T-15		60	20	
Shock Resistant Tool Steels	S-1	140	40	
	S-5, S-7	125	40	
TITANIUM ALLOY	Titanium Alloys	CP Titanium	85	25
		Ti-6Al-4V	65	20
NICKEL BASED ALLOY	Nickel Alloys	Monel® K-500	70	20
		Duranickel 301	55	15
	Iron-Based Super Alloys	A286, Incoloy® 825	80	25
		Incoloy® 600	55	15
		Pyromet X-15	70	20
	Nickel-Based Alloys	Inconel® 600, Inconel® 718,	60	20
Nimonic 90, NI-SPAN-C 902, RENE 41		60	20	
Inconel® 625		80	25	
Hastalloy B, Waspalloy		55	15	
Nimonic 75, RENE 88		50	15	
OTHER	Cast Irons	A536 (60-40-18)	225	70
A536 (120-90-02)		110	35	
A48 (Class 20)		160	50	
A48 (Class 40)		115	35	
A48 (Class 60)		95	30	

The Speed Chart recommendations apply when cutting 4" wide (100mm), annealed material with a bi-metal blade and flood sawing fluid:

ADJUST BAND SPEED FOR DIFFERENT SIZED MATERIALS

MATERIAL	BAND SPEED
1/4" (6mm)	Chart Speed + 15%
3/4" (19mm)	Chart Speed + 12%
1-1/4" (32mm)	Chart Speed + 10%
2-1/2" (64mm)	Chart Speed + 5%
4" (100mm)	Chart Speed - 0%
8" (200mm)	Chart Speed - 12%

ADJUST BAND SPEED FOR DIFFERENT FLUID TYPES

FLUID TYPES	BAND SPEED
Spray lube	Chart Speed - 15%
No fluid	Chart Speed - 30-50%

ADJUST BAND SPEED FOR HEAT TREATED MATERIALS

ROCKWELL	BRINELL	DECREASE BAND SPEED
Up to 20	226	-0%
22	237	-5%
24	247	-10%
26	258	-15%
28	271	-20%
30	286	-25%
32	301	-30%
36	336	-35%
38	353	-40%
40	371	-45%

Reduce band speed 50% when sawing with carbon blades

BLADE BREAK-IN

Getting Long Life from a New Band Saw Blade

WHAT IS BLADE BREAK-IN?

A new band saw blade has razor sharp tooth tips. In order to withstand the cutting pressures used in band sawing, tooth tips should be honed to form a micro-fine radius. Failure to perform this honing will cause microscopic damage to the tips of the teeth, resulting in reduced blade life.

Why Break-In a Band Saw Blade?

Completing a proper break-in on a new band saw blade will dramatically increase its life.

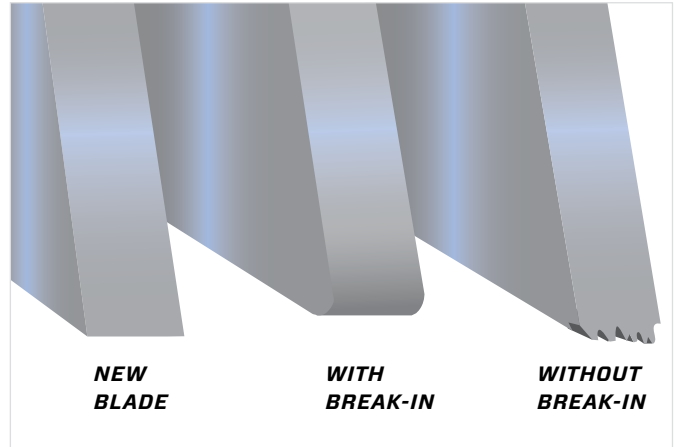

HOW TO BREAK IN A BLADE

Select the proper band speed for the material to be cut (see chart on page 32)

Reduce the feed force/rate to achieve a cutting rate 20% to 50% of normal (soft materials require a larger feed rate reduction than harder materials)

Begin the first cut at the reduced rate. Make sure the teeth are forming a chip. Small adjustments to the band speed may be made in the event of excessive noise/vibration

During the first cut, increase feed rate/force slightly once the blade fully enters the workpiece

With each following cut, gradually increase feed rate/force until normal cutting rate is reached

**FOR FURTHER ASSISTANCE WITH BREAK-IN PROCEDURES,
CONTACT LENOX TECHNICAL SUPPORT 800-642-0010**



CARBON ***BAND SAW BLADES***

<i>NEO-TYPE</i> [®] & Flex Back.....	35
#32 Wood & Friction Band	36

NEO-TYPE®

Hard Back Carbon Steel Blade

STRAIGHTER, EASIER CUT

The body of this blade is heat treated for extra stability while cutting

Recommended for use at band speeds less than 4,000 feet (1,200 meters) per minute

DESIGNED FOR USE ON VERTICAL CONTOUR SAWS AND SMALL CUT-OFF SAWS

Perfect for utility cutting of a wide variety of materials

WIDTH X THICKNESS		TOOTH FORM								
		STANDARD						HOOK		
		RAKER SET TPI			WAVY TPI			RAKER SET TPI		
IN	MM	6	8	10	14	18	24	3	4	6
1/4 x .025	6.4 x 0.64			◆	◆	◆	◆		◆	◆
3/8 x .025	9.5 x 0.64		◆	◆	◆	◆		◆	◆	◆
1/2 x .025	12.7 x 0.64	◆	◆	◆	◆	◆	◆		◆	
5/8 x .032	16 x 0.80			◆	◆					
3/4 x .035	19 x 0.90	◆	◆	◆	◆	◆		◆	◆	
1 x .035	25.4 x 0.90	◆	◆	◆	◆			◆		



APPLICATION

Aluminum
Brass
Bronze
Copper
Fiberglass

Carbon
Graphite
Plastics
Mild Steels

FLEX BACK

Carbon Steel Blade

EXCELLENT FATIGUE LIFE

Designed to cut a wide variety of materials

Flexible carbon steel is very durable even at high band speeds—up to 15,000 feet (4,500 meters) per minute

DESIGNED FOR USE ON VERTICAL CONTOUR SAWS

Perfect for utility cutting of a wide variety of materials

WIDTH X THICKNESS		TOOTH FORM									
		STANDARD			HOOK				SKIP		
		RAKER SET TPI			RAKER SET TPI				ALT TPI	RAKER SET TPI	
IN	MM	6	10	14	2	3	4	6	2	4	6
1/4 x .025	6.4 x 0.64		◆	◆			◆	◆		◆	◆
3/8 x .025	9.5 x 0.64		◆	◆		◆	◆	◆			
1/2 x .025	12.7 x 0.64	◆	◆	◆		◆	◆	◆			
3/4 x .032	19 x 0.80				◆	◆	◆	◆			
1 x .035	25.4 x 0.90				◆	◆					
2 x .035	50.8 x 0.90								◆		



APPLICATION

Aluminum
Brass
Bronze
Copper
Fiberglass

Carbon
Graphite
Plastics
Wood



#32 WOOD

Specialized Woodworking Applications

STRAIGHTER, EASIER CUTTING

Manufactured with a heavier gauge (.032") flexible carbon steel material

DESIGNED FOR CONTOUR CUTTING OF WOOD

Perfect for furniture manufacturing operations

Note: Not recommended for blades shorter than 15' (4500mm) long. If shorter blade is required, LENOX Flex Back is recommended



WIDTH X THICKNESS		TOOTH FORM					
		RAKER SET TPI			HOOK ALTERNATE TPI		
IN	MM	2	3	4	2	3	4
1/4 x .032	6.4 x 0.80			◆			◆
3/8 x .032	9.5 x 0.80		◆	◆	◆	◆	◆
1/2 x .032	12.7 x 0.80	◆	◆	◆		◆	

APPLICATION

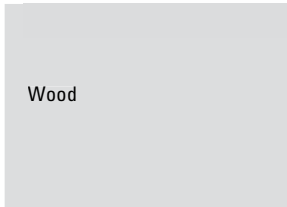

Wood

FRICITION BAND

Friction Cutting Operations

FAST CUTTING

Special set design for increased frictional heat

LONG LASTING

Special silicon carbon steel provides extended fatigue life

Note: Operates at band speeds up to 20,000 feet per minute (6,000 meters per minute)



WIDTH X THICKNESS		TOOTH FORM
		STANDARD LENOX SET TPI
IN	MM	10
1 x .035	25.4 x 0.90	◆

APPLICATION

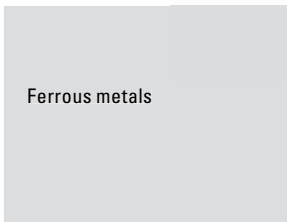

Ferrous metals

SAWING AND METAL WORKING FLUIDS

<i>BAND-ADE</i> [®] & <i>SAW MASTER</i> [™]	38
Machine Cleaner & LUBE TUBE.....	39
<i>MICRONIZER</i> [®] & <i>MICRONIZER, Jr.</i>	40
<i>LENOX LUBE</i> [®] & C/AI Lube.....	41
<i>LENOX PROTOOL LUBE</i> [®] & ANTI-SPATTER ...	42
Fluids Reference Chart.....	43
Tachometer, Blade Alignment Gauge, Tension Meter, Refractometer & <i>TRAVERSE MASTER</i> [®]	44
<i>SAWCALC</i> [®]	45



BAND-ADE®

Semi-Synthetic Sawing Fluid

General purpose flood coolant designed for light to moderate-duty machining applications involving both ferrous and non-ferrous metals

EXTENDS BLADE LIFE

Increased lubrication aids in chip formation and evacuation

EXCEPTIONAL COOLING

Water-soluble formulation helps to reduce frictional heat and improves cutting performance

INCREASES PRODUCTIVITY

Faster cutting and reduced machine wear increases efficiency

ENVIRONMENTALLY FRIENDLY

Products are biodegradable, safe for the operator to use, and do not contain harmful chemicals like chlorine and sulphur

SURFACES CAN BE WELDED AND PAINTED OVER



RATIO	REFRACTOMETER
10:1 (10%)	3.5
15:1 (6.7%)	2.6
20:1 (5%)	1.7

PROD NO	CONTAINER SIZE		CONTAINERS PER CASE
	GALLON	LITER	
68004	1	3.8	4
68005	2-1/2	9.5	2
68003	5	18.9	—
68001	55	208.2 drum	—
68007	275	1,040.9 tote	—

NFPA CODE SPECS

HMIS/WHMIS
 HEALTH INDEX – 0
 FLAMMABILITY – 0
 REACTIVITY – 0
 PERSONAL PROTECTION – A



Not recommended for use as a spray lubricant. Mix this product with water as recommended

SAW MASTER™

Synthetic Sawing Fluid

Specially formulated flood coolant for light to moderate-duty applications on ferrous metals and alloys

LONGER BLADE LIFE. FASTER CUTTING.

Lubricates and cools to get the most from your blade or tool

REJECTS MOST TRAMP OILS

Unwanted oils can be separated and removed to keep the fluid performing longer

EXCELLENT SUMP LIFE

Advanced anti-microbial agents control bacterial growth and prevent rancidity, which lowers fluid replacement costs

CAN BE USED IN MOST HARD WATER APPLICATIONS

Eliminates filtration problems and residue

SURFACES CAN BE WELDED AND PAINTED OVER

LOW TO NON-FOAMING



RATIO	REFRACTOMETER
5:1 (20%)	6.4
10:1 (10%)	3.2
15:1 (6.7%)	2.4
20:1 (5%)	1.6

PROD NO	CONTAINER SIZE		CONTAINERS PER CASE
	GALLON	LITER	
68064	1	3.8	4
68061	5	18.9	—
68062	55	208.2 drum	—
68063	275	1,040.9 tote	—

NFPA CODE SPECS

HMIS/WHMIS
 HEALTH INDEX – 1
 FLAMMABILITY – 0
 REACTIVITY – 0
 PERSONAL PROTECTION – A



Not recommended for use as a spray lubricant. Mix this product with water as recommended

MACHINE CLEANER

Prepares Your Sump for the use of LENOX Sawing Fluids

CLEANS THE MACHINE BETWEEN CHARGES

Eliminates bacteria and fungi

EXTENDS THE LIFE OF THE SAWING FLUID

Helps loosen dirt and contaminants for easier removal and a cleaner system

PREVENTS CONTAMINATION WHEN CONVERTING FLUIDS



PROD NO	CONTAINER SIZE		CONTAINERS PER CASE
	GALLON	LITER	
68006	1	3.8	4

For industrial use only. Mix this product with water as recommended

HMIS/WHMIS
 HEALTH INDEX – 1
 FLAMMABILITY – 0
 REACTIVITY – 0
 PERSONAL PROTECTION – A

NFPA CODE SPECS



LUBE TUBE

Manually Applied Lubricant Stick

EXTREME PRESSURE LUBRICANT

Prevents the build-up of frictional heat

DESIGNED TO BE APPLIED TO BAND SAW BLADES AND OTHER CUTTING TOOLS

Improves overall tool life and productivity when sawing, drilling, milling, grinding, threading and tapping. Works well on abrasives (belts, sanding discs and pads)

CAN BE USED ON FERROUS AND NON-FERROUS METALS, ALUMINUM GATES AND RISERS, PLATES AND EXTRUSIONS

BIODEGRADABLE, NON-TOXIC AND NON-STAINING



PROD NO	CONTAINER SIZE		TUBES PER CASE
	OUNCES	GRAMS	
68020LNx	14.5	411.1	12

HMIS/WHMIS
 HEALTH INDEX – 0
 FLAMMABILITY – 0
 REACTIVITY – 0
 PERSONAL PROTECTION – A

NFPA CODE SPECS





MICRONIZER®

Precision Lubricant Applicator

DESIGNED TO DELIVER A SMALL AMOUNT OF LUBRICANT

Aids in tooth penetration and chip formation, reducing heat and improving tool life

PRECISE FLUID PUMP AND AIR PRESSURE CONTROLS

Ensures the correct amount of lubricant is applied to the tool

A VARIETY OF NOZZLES ARE AVAILABLE

The LENOX Saw Nozzle is recommended for most sawing applications, and is standard on the one line unit (product no 68090)

RECOMMENDED FOR PRODUCTION SAWING OPERATIONS

For larger band saw machines using 1-1/4" (34mm) and wider blades



PROD NO	DESCRIPTION
68090	1 Line Unit w/LENOX Saw Nozzle, 32 oz. (.95 liter) reservoir and manual on/off switch
1770276	1 Line Unit w/Flex Nozzle, 32 oz. (.95 liter) reservoir and manual on/off switch
1770277	1 Line Unit w/Copper Nozzle, 32 oz. (.95 liter) reservoir and manual on/off switch
1770278	1 Line Unit w/LENOX Saw Nozzle, 32 oz. (.95 liter) reservoir and 110V solenoid valve
1770279	1 Line Unit w/LENOX Saw Nozzle, 32 oz. (.95 liter) reservoir and 220V solenoid valve
1770280	1 Line Unit w/Flex Nozzle, 32 oz. (.95 liter) reservoir and 110V solenoid valve
1770401	1 Line Unit w/Copper Nozzle, 32 oz. (.95 liter) reservoir and 110V solenoid valve
1770402	2 Line Unit w/LENOX Saw Nozzle, 32 oz. (.95 liter) reservoir and manual on/off switch
1770403	2 Line Unit w/Flex Nozzle, 32 oz. (.95 liter) reservoir and manual on/off switch
1770188	2 Line Unit w/Copper Nozzle, 32 oz. (.95 liter) reservoir and manual on/off switch
1770406	2 Line Unit w/LENOX Saw Nozzle, 32 oz. (.95 liter) reservoir and 110V solenoid valve
1770407	2 Line Unit w/Flex Nozzle, 32 oz. (.95 liter) reservoir and 110V solenoid valve
1770408	2 Line Unit w/Copper Nozzle, 32 oz. (.95 liter) reservoir and 110V solenoid valve

MICRONIZER, JR.

Lubricant Applicator

PORTABLE DESIGN FOR USE ON MANY APPLICATIONS

Strong mounting magnets hold unit in place, but allow it to be moved to different machines

FOR SMALLER BAND SAW MACHINES & OTHER MACHINE TOOLS

A clean, economical method of providing lubrication

CONVENIENT DESIGN

Choice of two reservoir capacities, 7 oz (200ml) or 37 oz (1.1liter)

SEVERAL NOZZLE STYLES AVAILABLE

PROD NO	DESCRIPTION
68260	7 oz (200ml) Unit with copper nozzle, Shut-off valve and 6' (1.8m) of 1/4" (6mm) tubing
68160	7 oz (200ml) Unit with copper nozzle, Shut-off valve and 6' (1.8m) of 1/8" (3mm) tubing
68258	7 oz (200ml) Unit with flex nozzle, Shut-off valve and 6' (1.8m) of 1/4" (6mm) tubing
68158	7 oz (200ml) Unit with flex nozzle, Shut-off valve and 6' (1.8m) of 1/8" (3mm) tubing
68161	37 oz (1.1 liter) Unit with copper nozzle, Shut-off valve and 6' (1.8m) of 1/4" (6mm) tubing
68159	37 oz (1.1 liter) Unit with flex nozzle, Shut-off valve and 6' (1.8m) of 1/4" (6mm) tubing



LENOX LUBE®

Clean, Synthetic Lubricant for Spray Applications

Advanced formula enables superior cutting performance when Minimum Quantity Lubrication (MQL) is required

EXTENDS TOOL LIFE

Extreme pressure lubricant reduces frictional heat, prevents chip welding, and delivers an excellent workpiece finish

CLEAN AND ENVIRONMENTALLY FRIENDLY

Synthetic, water-based formulation is safe for the shop and operator

REDUCES COSTS

No disposal costs and use only ounces per day

OPTIMUM PERFORMANCE ON FERROUS METALS

Use with our MICRONIZER® systems to lubricate carbon/alloy steels and stainless steels. Works best on pipe and thin-walled tubing

SURFACES CAN BE WELDED AND PAINTED OVER



PROD NO	CONTAINER SIZE		CONTAINERS PER CASE
	GALLON	LITER	
68014	1	3.8	4
68018	5	18.9	—
68017	55	208.2 drum	—
68016	275	1,040.9 tote	—

NFPA CODE SPECS

HMIS/WHMIS
 HEALTH INDEX – 0
 FLAMMABILITY – 0
 REACTIVITY – 0
 PERSONAL PROTECTION – A



Use this product as it comes from the container – do not mix with water.

C/AI LUBE

High Lubricity Formulation for Spray Applications

Synthetic oil formulated for cutting solids and structurals in a Near Dry Machining (NDM) application

WORKS EFFECTIVELY ON ALL TYPES OF MATERIALS

Use on a variety of steels and non-ferrous metals. Works well on large structural beams, small solids, and all shapes of aluminum (billets, plates and castings)

INCREASED PRODUCTIVITY

Enhances lubrication for higher cutting speeds and feed rates

EXTENDS TOOL LIFE

Enables tooth penetration and chip formation which decreases wear on the machine and blade

CONTROL COSTS

Decreases the volume consumed and lowers replacement costs when used with our MICRONIZER systems



PROD NO	CONTAINER SIZE		CONTAINERS PER CASE
	GALLON	LITER	
68024	1	3.8	4
68026	5	18.9	—
68025	55	208.2 drum	—
68028	275	1,040.9 tote	—

NFPA CODE SPECS

HMIS/WHMIS
 HEALTH INDEX – 0
 FLAMMABILITY – 1
 REACTIVITY – 0
 PERSONAL PROTECTION – A



Use this product as it comes from the container – do not mix with water.



LENOX PROTOOL LUBE®

Extends Tool Life

A UNIQUE SYNTHETIC EMULSION DESIGNED TO INCREASE TOOL LIFE

For cutting, milling, reaming, tapping and drilling metal, wood and plastics

SHORTENS CUTTING TIME BY UP TO 50%

Provides smoother, cleaner cutting and dramatically longer blade life

REDUCES HEAT AND FRICTION

Water-soluble so it cleans up with water

BIODEGRADABLE AND NON-TOXIC

EASY TO USE, FLIP-TOP BOTTLE FITS IN YOUR TOOL BOX



PROD NO	CONTAINER SIZE		CONTAINERS PER CASE
	GALLON	LITER	
68064	6 oz	.17	12
68061	1	3.8	4
68062	5	18.9	—
68063	55	208.2 drum	—

NFPA CODE SPECS

HMIS/WHMIS
 HEALTH INDEX – 1
 FLAMMABILITY – 0
 REACTIVITY – 0
 PERSONAL PROTECTION – A



Use this product as it comes from the container – do not mix with water.

ANTI-SPATTER

Wipe Away Welding Spatter

REDUCE SECONDARY PROCESSING STEPS

Provides lubrication so spatter easily wipes away

SAFE TO USE

Non-toxic, non-explosive, non-combustible, and non-carcinogenic.

No silicone or chlorine. No CFCs.

PROTECTS JIGS AND FIXTURES

IMPROVES WELD JOINTS

SURFACES CAN BE WELDED AND PAINTED OVER



PROD NO	CONTAINER SIZE		CONTAINERS PER CASE
	GALLON	LITER	
69041	33 fl oz	946 ml trigger spray bottle	12
69039	1	3.8	4
69038	5	18.9	—
69037	55	208.2 drum	—

NFPA CODE SPECS

HMIS/WHMIS
 HEALTH INDEX – 0
 FLAMMABILITY – 1
 REACTIVITY – 0
 PERSONAL PROTECTION – A



FLUID REFERENCE CHART

Properties and Applications

LENOX® METAL-WORKING FLUID	TYPE			METALS				APPLICATIONS					
	FLOOD COOLANT	SPRAY LUBRICANT	MANUAL APPLICATION	USE WITH SOLID METALS	USE WITH STRUCTURAL METALS	USE WITH FERROUS METALS	USE WITH NON-FERROUS METALS	BAND SAWING	CIRCULAR SAWING	DRILLING	TAPPING	MILLING	GRINDING
<i>BAND-ADE®</i>	•			•	•	•	•	•	•	•		•	
<i>SAW MASTER™</i>	•			•	•	•		•	•	•			•
<i>LENOX LUBE®</i>		•		•	•	•		•	•	•	•	•	•
<i>C/AI LUBE</i>		•		•	•	•	•	•	•	•	•	•	•
<i>LENOX PROTOOL LUBE®</i>			•	•	•	•	•		•	•	•		

LENOX METALWORKING FLUID	CHEMICAL PROPERTIES							
	TYPE	COLOR	BIOCIDES	RUST/CORROSION INHIBITORS	CONTAINS MINERAL OR PETROLEUM OIL	CONTAINS CHLORINE OR SILICONE	CONTAINS SULFUR/SULPHONATES	CONTAINS CARCINOGENS
<i>BAND-ADE</i>	Semi-Synthetic	Translucent Pink	Yes	Yes	No	No	No	No
<i>SAW MASTER</i>	Synthetic	Translucent Pink	Yes	Yes	No	No	No	No
<i>LENOX LUBE</i>	Synthetic Emulsion	Translucent Green	Yes	Yes	No	No	No	No
<i>C/AI LUBE</i>	Synthetic Oil	Translucent Blue	No	Yes	No	No	No	No
<i>LENOX PROTOOL LUBE®</i>	Synthetic Emulsion	Translucent Yellow	Yes	Yes	No	No	No	No

LENOX METAL REMOVAL FLUID	PHYSICAL PROPERTIES						
	SOLUBILITY IN WATER	SPECIFIC GRAVITY (H ₂ O=1)	pH RANGE	VISCOSITY AT 72°F	FLASH POINT	FREEZING POINT	BOILING POINT
<i>BAND-ADE</i>	100%	1.02	8.8 - 9.2	43 SUS	None	-6°C/21°F	99°C/210°F
<i>SAW MASTER</i>	100%	1.076	9.7 - 10.0	42.7 SUS	None	-12°C/10°F	99°C/210°F
<i>LENOX LUBE</i>	100%	1.015	7.8 - 8.2	60 SUS	None	-7°C/19°F	99°C/210°F
<i>C/AI LUBE</i>	Insoluble	0.823	N/A	121 SUS	COC 290°F	N/A	N/A
<i>LENOX PROTOOL LUBE</i>	100%	1.03	8.0 - 8.5	500 SUS	None	-25°C/-13°F	99°C/210°F

DILUTION RATIO*	FLUID CONTENT	WATER CONTENT	APPLICATIONS
5:1	20%	80%	Heavy-duty sawing, difficult milling
10:1	10%	90%	Moderate to heavy-duty sawing, drilling, tapping and milling
20:1	5%	95%	Light-duty work
30:1	3%	97%	Grinding, light-duty work

*Dilution ratios are for flood coolants only. LENOX recommends 5:1 or 10:1, depending on the severity of the operation



TACHOMETER

Accurate Band Speed Measurement

Running at the proper band speed is essential for optimum tool life. Use this precision tool to calibrate band saw machine internal tachometer. Check band speeds on machines that don't have a tachometer



PROD NO	DESCRIPTION
62139	Tachometer

TENSION METER

Measures Band Tension

Properly tensioned band saw blades cut straighter, longer. Durable construction: made with lightweight cast aluminum. Easy to use: attach to blade, apply tension and read the PSI



PROD NO	DESCRIPTION
62126	Tension Meter

BLADE ALIGNMENT GAUGE

For Straight Cutting

Proper alignment is critical for straight cutting. Using this gauge allows for easy measurement of blade alignment, so proper adjustment of band guide assemblies can be made. Easy to use: clip the blade alignment to the back of the blade and use a machinist's square to see if the blade is perpendicular to the bed



PROD NO	DESCRIPTION
62125	Blade Alignment Gauge

TRAVERSE MASTER®

Measures and Reports Feed Rate

Optimize chip loads to achieve fast cutting without detrimental effects on blade life. Accurately achieve cutting rates recommended by LENOX SAWCALC®. Precision meter: provides readout of feed rate in inches (or millimeters) per minute. Powered by a 12v DC power supply or rechargeable battery pack (both included)



PROD NO	DESCRIPTION
62140	Traverse Master
62141	Traverse Master

(includes international plug adaptor)

REFRACTOMETER

Measures Sawing Fluid Concentration

IMPROVE FLUID EFFECTIVENESS

Maintaining the proper water to fluid ratio increases tool life and ensures longer fluid performance

EASY TO USE AND CALIBRATE

Calibrate with a drop of water, put a small amount of sawing fluid in the refractometer. A quick look through the lens shows the fluid ratio.

PROD NO	DESCRIPTION
68012	Refractometer



SAWCALC®

Cut Smart with SAWCALC - Web-Enabled Solution for Your Cutting Challenges

CUSTOMIZED, ACCURATE RECOMMENDATIONS TO OPTIMIZE BLADE LIFE

Identify the right LENOX blade for the job

Determine the correct parameters to satisfy your cutting goals

HIGHLY TECHNICAL, ENGINEERED SOLUTIONS

Built-in intelligence based on years of engineering experience

Over 35,000 metals and 9,000 band saws inside the program

FREE, EASY TO USE AND ALWAYS UPDATED

SAWCALC is updated regularly to include the latest machines, metals, and LENOX products

**VISIT SAWCALC.COM
TO GET YOUR RECOMMENDATION TODAY!**

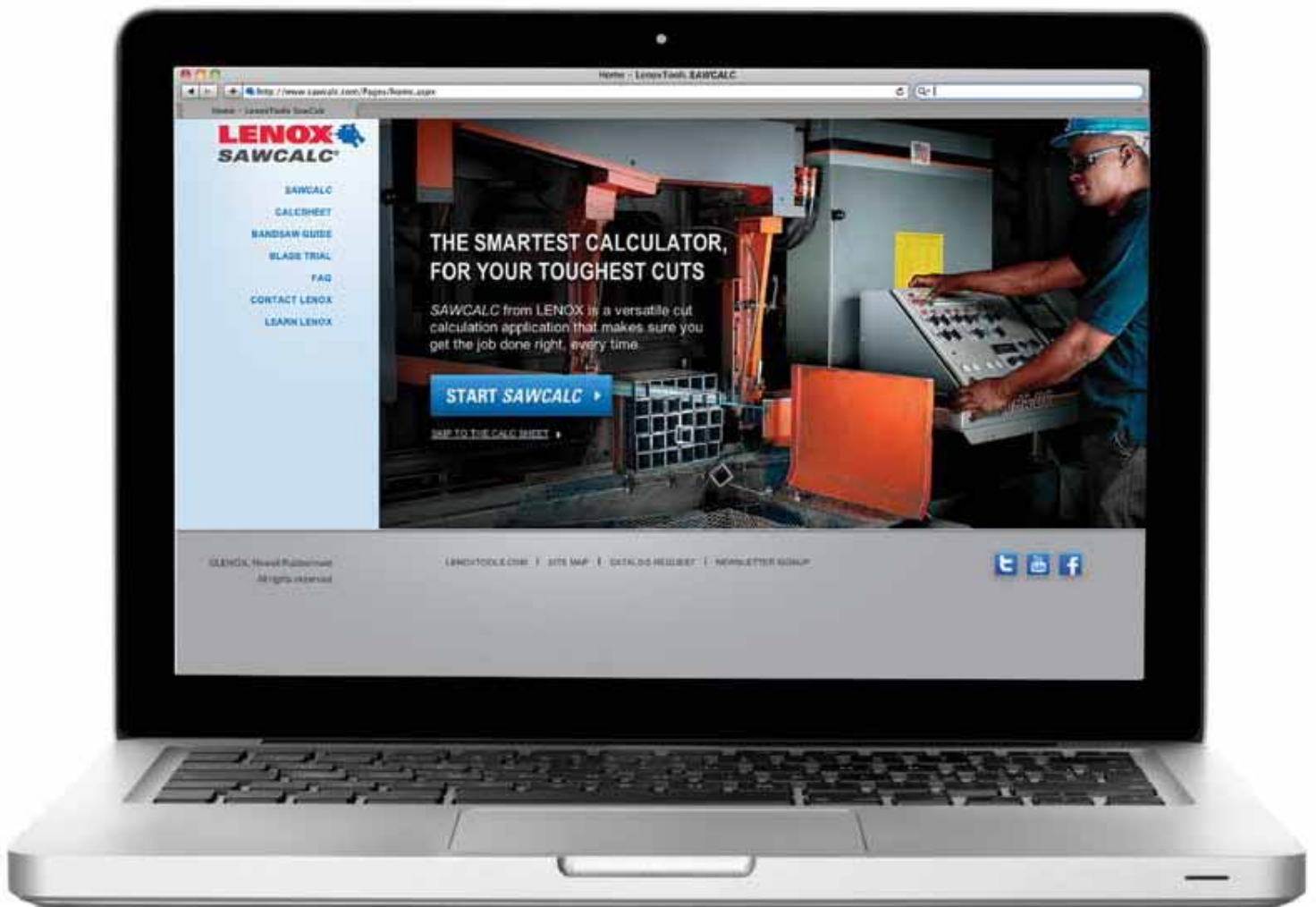





POWER ***TOOL***
ACCESSORIES



4,2mm

BI-METAL

LENNOX®



D



T2™ RECIPROCATING SAW BLADES

LENOX Gold®.....	50
LAZER®.....	52
Demolition.....	53
Bi-metal.....	54
LENOX DIAMOND™ & Carbide Grit.....	56
Carbide Tipped, Fleam Ground, Pallet Dismantling.....	57
Reciprocating Saw Blade Kits.....	58
Blade, TPI & Blade Length Selection Guides.....	59
Cross Reference Chart.....	60
MASTER-BAND™ & WOLF-BAND® Portable Bands...	62



LENOX Gold® RECIPROCATING SAW BLADES

Longest Lasting Blade. Ever.

EXTENDED BLADE LIFE

T2™ Technology and precision applied titanium coating help dissipate heat making blades last longer

FASTER CUTS

Titanium coating makes teeth more wear resistant so they stay sharp for quicker cuts

LONGER BLADE LIFE AND VERSATILITY

T2 technology's patented tooth design delivers longer blade life and enables faster cutting in the widest array of cutting applications



Wood



Metal



Demolition



LAZER® Extreme Metal

LENOX *Gold* RECIPROCATING SAW BLADES (CONTINUED)

	TPI	LENGTH X WIDTH X THICKNESS		5-PACK PROD NO	25-PACK PROD NO	APPLICATION
		IN	MM			
WOOD	6	6 x 7/16 x .050	152 x 11 x 1.3	21063676GRC	—	
	6	6 x 3/4 x .050	152 x 19 x 1.3	21060656GR	21074B656GR	
	6	9 x 3/4 x .050	229 x 19 x 1.3	21062956GR	21076B956GR	
	6	12 x 3/4 x .050	305 x 19 x 1.3	21061156GR	21075B156GR	
METAL	10	6 x 3/4 x .035	152 x 19 x .9	21064610GR	21078B610GR	
	10	8 x 3/4 x .050	203 x 19 x 1.3	21065810GR	21079B810GR	
	14	4 x 3/4 x .035	102 x 19 x .9	21066414GR	21080B414GR	
	14	6 x 3/4 x .035	152 x 19 x .9	21067614GR	21081B614GR	
	18	4 x 3/4 x .035	102 x 19 x .9	21068418GR	21082B418GR	
	18	6 x 3/4 x .035	152 x 19 x .9	21069618GR	21083B618GR	
	18	8 x 3/4 x .035	203 x 19 x .9	21070818GR	21084B818GR	
	24	4 x 3/4 x .035	102 x 19 x .9	21071424GR	—	
	24	6 x 3/4 x .035	152 x 19 x .9	21072624GR	21086B624GR	
	24	8 x 3/4 x .035	203 x 19 x .9	21073824GR	21087B824GR	
DEMOLITION	6	6 x 1 x .062	152 x 22 x 1.6	210886066GR	21220B6066GR	
	6	9 x 1 x .062	229 x 22 x 1.6	21090966GR	21222B966GR	
	6	12 x 1 x .062	305 x 22 x 1.6	21091106GR	21223B106GR	
	10	9 x 1 x .062	229 x 22 x 1.6	21089960GR	21221B960GR	
EXTREME METAL CUTTING	8	6 x 1 x .042	152 x 25 x 1.07	210926108GR	—	
	8	9 x 1 x .042	229 x 25 x 1.07	210969108GR	—	
	10	6 x 1 x .042	152 x 25 x 1.07	210936110GR	21225B6110GR	
	10	9 x 1 x .042	229 x 25 x 1.07	210979110GR	21229B9110GR	
	10	12 x 1 x .042	305 x 25 x 1.07	2110012110GR	21237B12110GR	
	14	6 x 1 x .042	152 x 25 x 1.07	210946114GR	21226B6114GR	
	14	9 x 1 x .042	229 x 25 x 1.07	210989114GR	21235B9114GR	
	14	12 x 1 x .042	305 x 25 x 1.07	2110112114GR	21238B12114GR	
	18	6 x 1 x .042	152 x 25 x 1.07	210956118GR	21227B6118GR	
	18	9 x 1 x .042	229 x 25 x 1.07	210999118GR	21236B9118GR	
18	12 x 1 x .042	305 x 25 x 1.07	2110212118GR	21239B12118GR		

ICON REFERENCE CHART

WOOD	NAIL-EMBEDDED WOOD	CONTOUR WOOD	PLASTIC	THICK METAL	MEDIUM METAL	THIN METAL	NON-FEROUS METAL
DEMOLITION	FIRE & RESCUE	PLASTER & DRYWALL	CAST IRON	CEMENT BOARD	TILE	ABRASIVES	NATURAL STONE



PLUNGE CUTTING WOOD BLADE

Patent pending plunge cutting tooth design prevents blade from walking to deliver faster, easier plunge cuts



LAZER[®] RECIPROCATING SAW BLADES

Best for Heavy Metal Cutting

FAST AND EASY HEAVY METAL CUTTING

T2 technology's patented tooth design delivers longer blade life and enables faster cutting

OPTIMIZED FOR HIGHER PERFORMANCE

Reinforced tooth design ensures higher performance in the most demanding jobs

STRAIGHT CUTS

Wider than conventional blades, this blade cuts straighter



TPI	LENGTH X WIDTH X THICKNESS		2-PACK PROD NO	5-PACK PROD NO	25-PACK PROD NO	50-PACK PROD NO	APPLICATION STRUCTURAL
	IN	MM					
8	6 x 1 x .042	152 x 25 x 1.07	—	201926108R	20196B6108R	—	Structural Steels greater than 3/16"
8	9 x 1 x .042	229 x 25 x 1.07	—	201939108R	20195B9108R	—	
8	12 x 1 x .042	305 x 25 x 1.07	—	2019412108R	20197B12108R	—	
10	6 x 1 x .042	152 x 25 x 1.07	24901T6110R	201706110R	20171B6110R	—	Structural Steels and All Metals 3/16"–1/2"
10	9 x 1 x .042	229 x 25 x 1.07	24905T9110R	201769110R	20177B9110R	—	
10	12 x 1 x .042	305 x 25 x 1.07	24909T12110R	2018212110R	20183B12110R	—	
14	6 x 1 x .042	152 x 25 x 1.07	24902T6114R	201726114R	20173B6114R	227640SB6114R	Structural Steels and All Metals 3/32"–3/8"
14	9 x 1 x .042	229 x 25 x 1.07	24906T9114R	201789114R	20179B9114R	227660SB9114R	
14	12 x 1 x .042	305 x 25 x 1.07	24910T12114R	2018412114R	20185B12114R	—	
18	6 x 1 x .042	152 x 25 x 1.07	24903T6118R	201746118R	20175B6118R	227650SB6118R	Structural Steels and All Metals 1/16"–1/4"
18	9 x 1 x .042	229 x 25 x 1.07	24907T9118R	201809118R	20181B9118R	227670SB9118R	
18	12 x 1 x .042	305 x 25 x 1.07	24911T12118R	2019012118R	20191B12118R	—	

DEMOLITION RECIPROCATING SAW BLADES

Best for Demolition and Nail-Embedded Wood

DEMOLITION JOBS ARE EASIER

T2 technology's patented tooth design delivers longer blade life and enables faster cutting

MAXIMUM DURABILITY

The tallest blade on the market prevents bending and provides maximum control in the toughest demolition applications

AGGRESSIVE CUTS EVEN IN TIGHT SPACES

Each blade has an optimized blade geometry including an aggressive tang angle and tapered blade shape to allow for cutting in tight areas



TPI	LENGTH X WIDTH X THICKNESS		2-PACK PROD NO	5-PACK PROD NO	25-PACK PROD NO	50-PACK PROD NO	APPLICATION
	IN	MM					
6	6 x 1 x .062	152 x 22 x 1.6	205126066R	203706066R5	20514B6066R	—	
6	9 x 1 x .062	229 x 22 x 1.6	20598966R	20371966R5	20523B966R	227630SB966R	
6	12 x 1 x .062	305 x 22 x 1.6	20500106R	20373106R5	20485B106R	—	
10	9 x 1 x .062	229 x 22 x 1.6	20597960R	20372960R5	20524B960R	227620SB960R	



BI-METAL RECIPROCATING SAW BLADES

Long Lasting, Fast Cutting and Versatile

LONGER BLADE LIFE AND VERSATILITY

T2 technology's patented tooth design delivers longer blade life and enables faster cutting in the widest array of cutting applications

MINIMIZE FRICTION AND HEAT BUILD UP

Engineered for performance this blade can handle the widest variety of metal materials providing an optimized cutting experience



TPI	LENGTH X WIDTH X THICKNESS		1-PACK PROD NO	5-PACK PROD NO	25-PACK PROD NO	50-PACK PROD NO	APPLICATION
	IN	MM					
4	6 x 3/4 x .050	152 x 19 x 1.3	20574S634R	20575634R	—	—	
6	4 x 3/4 x .050	102 x 19 x 1.3	—	20449456RP	—	—	
6	6 x 3/4 x .050	152 x 19 x 1.3	20571S636RP	20570636RP	20497B636RP	—	
6	6 x 3/4 x .035	152 x 19 x .9	20559S606R	20560606R	20492B606R	—	
6	6 x 7/16 x .050	152 x 11 x 1.3	20557S676RC	20556676RC	—	—	
6	6 x 3/4 x .050	152 x 19 x 1.3	20573S656R	20572656R	20530B656R	227500SB656R	
6	9 x 3/4 x .050	229 x 19 x 1.3	20587S956R	20582956R	20558B956R	227520SB956R	
6	12 x 3/4 x .050	305 x 19 x 1.3	20586S156R	20585156R	20495B156R	227550SB156R	
10	6 x 3/4 x .035	152 x 19 x .9	20561S610R	20562610R	20493B610R	227610SB610R	
10	8 x 3/4 x .050	203 x 19 x 1.3	20581S810R	20580810R	20590B810R	227530SB810R	
10/14	6 x 3/4 x .050	152 x 19 x 1.3	20592650R*	20374650R5	20515B650R	—	
10/14	8 x 3/4 x .050	203 x 19 x 1.3	—	20577850R	20535B850R	—	
10/14	12 x 3/4 x .050	305 x 19 x 1.3	20584S110R	20583110R	20491B110R	227580SB110R	
10/14	6 x 3/4 x .035	152 x 19 x .9	—	12129635R	—	—	
10/14	8 x 3/4 x .035	203 x 19 x .9	—	12130835R	—	—	

* This item is a 2-pack

BI-METAL RECIPROCATING SAW BLADES (CONTINUED)



TPI	LENGTH X WIDTH X THICKNESS		1-PACK PROD NO	5-PACK PROD NO	25-PACK PROD NO	50-PACK PROD NO	APPLICATION
	IN	MM					
14	3-5/8 x 5/16 x .035	92 x 8 x .9	—	20520314RC	—	—	
14	4 x 3/4 x .035	102 x 19 x .9	20551S414R	20550414R	20488B414R	227600SB414R	
14	6 x 3/4 x .035	152 x 19 x .9	20565S614R	20564614R	20494B614R	227560SB614R	
14	8 x 3/4 x .035	203 x 19 x .9	—	21519814R	1855567	1855570	
14	9 x 3/4 x .050	225 x 19 x 1.3	205119514R*				
18	3-5/8 x 5/16 x .035	92 x 8 x .9	20522S318RC	20521318RC	—	—	
18	4 x 3/4 x .035	102 x 19 x .9	20553S418R	20552418R	20489B418R	227590SB418R	
18	6 x 3/4 x .035	152 x 19 x .9	20567S618R	20566618R	20529B618R	227510SB618R	
18	8 x 3/4 x .035	203 x 19 x .9	20563S818R	20578818R	20487B818R	227540SB818R	
18	12 x 3/4 x .035	305 x 29 x .9	—	21510118R	21511B118R	—	
24	4 x 3/4 x .035	102 x 19 x .9	20555S424R	20554424R	20490B424R	—	
24	6 x 3/4 x .035	152 x 19 x .9	20569S624R	20568624R	20496B624R	227570SB624R	
24	8 x 3/4 x .035	203 x 19 x .9	—	20579824R	—	—	

* This item is a 2-pack



LENOX DIAMOND™ RECIPROCATING SAW BLADES

Cuts Cast. Fast.

LASTS LONGER

Nickel alloy-brazed diamond particles maintain sharpness to keep cutting after conventional carbide grit fails

CUTS 3X FASTER*

A narrow kerf design enables thinner, faster cuts

STRAIGHT, CLEAN CUTS

Unlike bulky snap cutters which crush pipes and leave ragged, uneven cuts, LENOX DIAMOND cuts clean. Durable chrome alloy backing steel provides extra stability

**Speed measured cutting 4" cast iron pipe at maximum speed vs. the leading competitor*



LENGTH X WIDTH X THICKNESS		1-PACK	APPLICATION
IN	MM	PROD NO	
8 x 3/4 x .040	203 x 19 x 1	10833800RDG	Cast Iron, Tile, Brick and Natural Stone
DOUBLE TANG			
9 x 3/4 x .042	225 x 19 x 1.07	1766338	
11 x 3/4 x .042	275 x 19 x 1.07	1766356	

CARBIDE GRIT RECIPROCATING SAW BLADES

For Cutting Non-Metallic Materials

HIGH PERFORMANCE IN ABRASIVE MATERIALS

Cuts through tough materials that resist chip-forming, including ceramics, pipe, man-made stone, brick, marble and more

SMOOTH, QUICK CUTS

Uniformly applied, durable carbide grit particles on a flexible blade provide fast cuts without snagging or binding



LENGTH X WIDTH X THICKNESS		2-PACK	APPLICATION
IN	MM	PROD NO	
6 x 3/4 x .032	152 x 19 x .8	20505600RG	Fiberglass, Ceramic Tile, Cultured Marble, Clays, Brick
8 x 3/4 x .040	203 x 19 x 1	20576800RG	
10 x 3/4 x .050	254 x 19 x 1.3	20506100RG	



CARBIDE TIPPED RECIPROCATING SAW BLADES

Engineered to Cut the Toughest Materials

VERSATILE AND EFFECTIVE

Cuts tough materials including cement board, cast aluminum, pressure treated wood, engineered lumber, and more

ENGINEERED FOR FASTER PERFORMANCE

Triple chip tooth design cuts 25% faster than standard carbide blades and provides exceptional fatigue resistance



TPI	LENGTH X WIDTH X THICKNESS		1-PACK PROD NO	PROFILE	APPLICATION
	IN	MM			
3	8 x 3/4 x .050	203 x 19 x 1.3	205998535RCT	Straight	Fiberglass, Particle Board, Pressure-Treated
6	6 x 3/4 x .050	152 x 19 x 1.3	205966565RCT	Straight	Woods, Plywood,
6	6 x 3/4 x .050	152 x 19 x 1.3	205956563RCT	Contour	Cast Aluminum



EXTRA SHARP FLEAM GROUND RECIPROCATING BLADES

Fast, Clean Cutting in Wood or Plastic

BI-METAL CONSTRUCTION

Durable and flexible to survive nail strikes

FLEAM GROUND TOOTH FORM

Fast, clean wood cutting

IDEAL FOR CLEAN WOOD, PLASTIC PIPE AND TREE PRUNING



TPI	LENGTH X WIDTH X THICKNESS		5-PACK PROD NO	APPLICATION
	IN	MM		
6	6 x 3/4 x .050	152 x 19 x 1.3	121016W6R	Clean Wood, Plastics, Pruning
6	9 x 3/4 x .050	229 x 19 x 1.3	121029W6R	



PALLET DISMANTLING RECIPROCATING SAW BLADES

High Performance Cutting for Pallet Refurbishing

ENGINEERED FOR STRENGTH

Specially treated to enhance performance and withstand nail strikes to keep cutting fast

LONG CUTTING LIFE

Patented tooth design and a rounded nose provide long blade life and enable easy access in tight spots



TPI	LENGTH X WIDTH X THICKNESS		250-PACK PROD NO	APPLICATION
	IN	MM		
10	8 x 3/4 x .035	203 x 19 x .9	10729810RPC	Dismantling Pallets
10	10 x 3/4 x .035	254 x 19 x .9	107301010RPC	



RECIPROCATING SAW BLADE KITS



121439KPE
9 PIECE
GENERAL PURPOSE KIT
Includes Storage Case

QTY	PROD NO	TPI	LENGTH X WIDTH X THICKNESS	
			IN	MM
2	656R	6	6 x 3/4 x .050	152 x 19 x 1.3
2	624R	24	6 x 3/4 x .035	152 x 19 x .9
2	818R	18	8 x 3/4 x .035	203 x 19 x .9
2	810R	10	8 x 3/4 x .050	203 x 19 x 1.3
1	960R	10	9 x 7/8 x .062	229 x 22 x 1.6



1214412RKD
12 PIECE
DEMOLITION KIT
Includes Storage Case

QTY	PROD NO	TPI	LENGTH X WIDTH X THICKNESS	
			IN	MM
3	6066R	6	6 x 7/8 x .062	150 x 22 x 1.6
3	6114R	14	6 x 1 x .042	150 x 25 x 1.1
2	9114R	14	9 x 1 x .042	225 x 25 x 1.1
2	966R	6	9 x 7/8 x .062	225 x 22 x 1.6
2	960R	10	9 x 7/8 x .062	225 x 22 x 1.6



20502546A
5 PIECE
4" AND 6" BLADE ASSORTMENT

QTY	PROD NO	TPI	LENGTH X WIDTH X THICKNESS	
			IN	MM
1	414R	14	4 x 3/4 x .035	102 x 19 x .9
1	418R	18	4 x 3/4 x .035	102 x 19 x .9
1	614R	14	6 x 3/4 x .035	152 x 19 x .9
1	618R	18	6 x 3/4 x .035	152 x 19 x .9
1	656R	6	6 x 3/4 x .050	152 x 19 x 1.3



1839466
5 PIECE
METAL CUTTING KIT

QTY	PROD NO	TPI	LENGTH X WIDTH X THICKNESS	
			IN	MM
3	618R	18	6 x 3/4 x .035	152 x 19 x .9
2	818R	18	8 x 3/4 x .035	203 x 19 x .9



1839467
5 PIECE
WOOD CUTTING KIT

QTY	PROD NO	TPI	LENGTH X WIDTH X THICKNESS	
			IN	MM
3	656R	6	6 x 3/4 x .050	52 x 19 x 1.3
2	956R	6	9 x 3/4 x .035	29 x 19 x 1.3



1839465
5 PIECE
DEMOLITION KIT

QTY	PROD NO	TPI	LENGTH X WIDTH X THICKNESS	
			IN	MM
1	6066R	6	6 x 1 x .062	150 x 25 x 1.6
1	6114R	14	6 x 1 x .042	150 x 25 x 1.1
1	9114R	14	9 x 1 x .042	225 x 25 x 1.1
1	966R	6	9 x 1 x .062	225 x 25 x 1.6
1	960R	10	9 x 1 x .062	225 x 25 x 1.6



1073415RKG
15 PIECE KIT
Includes Storage Case

QTY	PROD NO	TPI	LENGTH X WIDTH X THICKNESS	
			IN	MM
5	614R	14	6 x 3/4 x .035	152 x 19 x .9
5	618R	18	6 x 3/4 x .035	152 x 19 x .9
5	656R	6	6 x 3/4 x .050	152 x 19 x 1.3

RECIPROCATING SAW BLADE SELECTION GUIDE

	WOOD	NAIL-EMBEDDED WOOD	NON-FERROUS METAL	DEMOLITION	FIRE & RESCUE	PLASTICS & COMPOSITES	THICK METAL	MEDIUM METAL	THIN METAL	DRYWALL/ PLASTER	CEMENT BOARD	CAST IRON	ABRASIVES
BEST	LENOX GOLD®									CARBIDE TIPPED	LENOX DIAMOND™		
BETTER	BI-METAL	LAZER®	BI-METAL		LAZER			BI-METAL	LENOX DIAMOND	CARBIDE GRIT			
GOOD	—	BI-METAL	—		BI-METAL			—	CARBIDE GRIT	—			

TEETH PER INCH SELECTION GUIDE

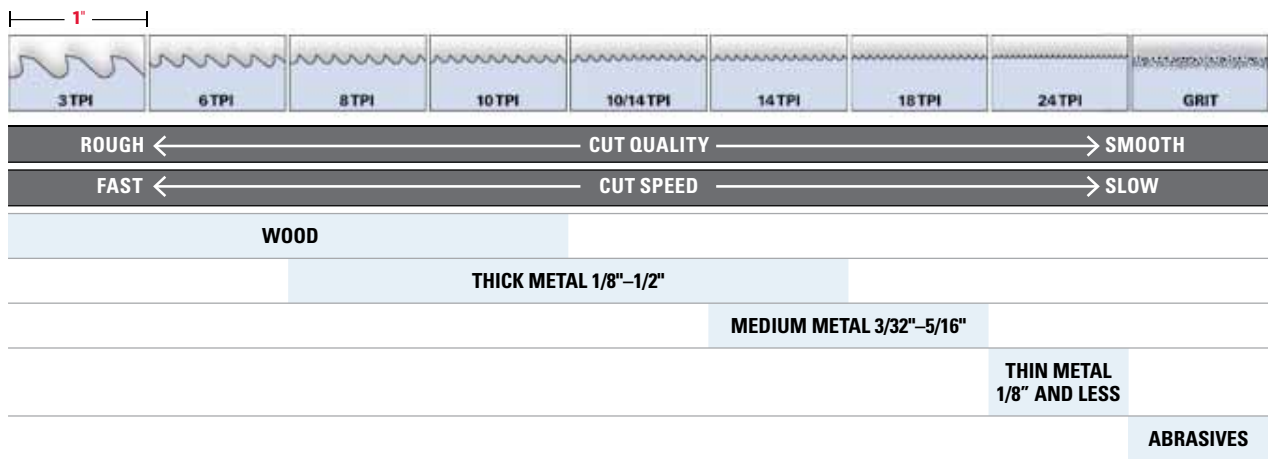

BLADE LENGTH SELECTION GUIDE

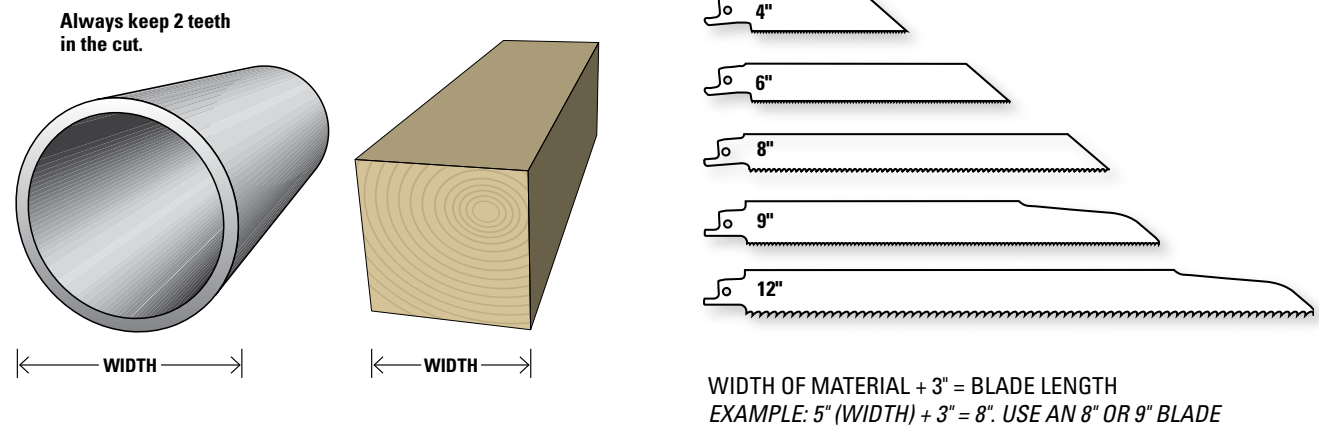













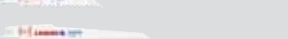
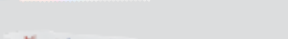
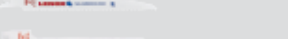

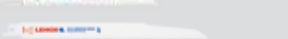
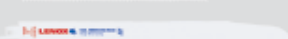
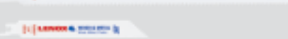





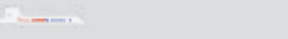
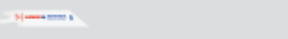

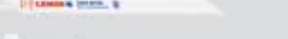
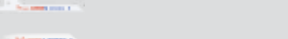

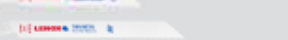

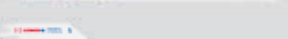

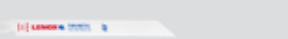
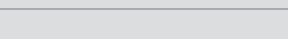

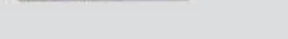

RECIPROCATING SAW BLADES CROSS REFERENCE CHART

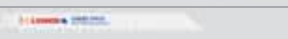
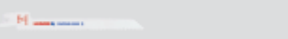
	TPI	LENGTH		DESC	SHAPE	BOSCH® / BOSCH EDGE	DEWALT®	MILWAUKEE®/ MILWAUKEE ICE	MK MORSE®
		IN	MM						
LENOX Gold®	6	6	152	676GRC					
	6	6	152	656GR					
	6	6	152	6066GR					
	6	9	229	956GR					
	6	9	229	966GR					
	6	12	305	156GR					
	6	12	305	106GR					
	8	6	152	6108GR					
	8	9	229	9108GR					
	10	6	152	610GR					
	10	6	152	6110GR					
	10	8	203	810GR					
	10	9	229	9110GR					
	10	12	305	12110GR					
	14	4	102	414GR					
	14	6	152	614GR					
	14	6	152	6114GR					
	14	9	229	9114GR					
	14	12	305	12114GR					
	18	4	102	418GR					
	18	6	152	618GR					
	18	6	152	6118GR					
	18	8	203	818GR					
	18	9	229	9118GR					
	18	12	305	12118GR					
	24	4	102	424GR					
	24	6	152	624GR					
	24	8	203	824GR					
LENOX DIAMOND™	Grit	9	225	800DTDG					—
	Grit	11	275	100DTDG					—
LAZER®	8	6	152	6108R		RSM6X2, RSM7X2 RESM6X2	—	5700, 5701	—
	8	9	229	9108R		RSM9X2, RESM9X2	—	5705, 5706	—
	8	12	305	12108R		RSM12X2	—	5710, 5711	—
	10	6	152	6110R		S123XF, RPRM6, SAPP6, RESM6X2	—	5712, 4712	RB66210, RBFR66210W, RBMC64210
	10	9	229	9110R		RESM9X2	—	5713, 4713	RB1010, RBMC95010
	10	12	305	12110R		RAP1210	—	5714	RB1210, RB126210, RBFR126210W, RBMC125010
	14	6	152	6114R		RCM6X2, RECM6X2	DWA4186	5782, 4782	RBFR66214W, RBMC64214
	14	9	229	9114R		RCM9X2, RECM9X2	DWA4188	5787, 5795, 4788	RBFR96214W, RBMC95014
	14	12	305	12114R		RCM12X2	DWA4112	5794	RB1214, RBFR126214W, RBMC125014, RBU10514
	18	6	152	6118R		RCTM6X2, RECM6X2	—	5784, 4784	RB65018, RBMC64218
	18	9	229	9118R		RECM9X2	—	5788, 5798, 4788	RBMC95018
	18	12	305	12118R		—	—	5789	RBMC125018

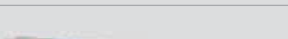

	TPI	LENGTH		DESC	SHAPE	BOSCH® / BOSCH EDGE		MILWAUKEE®/ MILWAUKEE ICE		MK MORSE®
		IN	MM			DEWALT®	MILWAUKEE ICE			
DEMOLITION	6	6	152	6066R		RDN6V	DW4862	5021, 5701	RB66206C	
	6	9	229	966R		RDN9V	DW4863	5026	RB96206	
	6	12	305	106R		RDN12V	DW4806, DW4806B, DW4845, DW4877	5027	RB126206	
	10	9	229	960R		REDM6X2, REDM9X2	—	—	RB96210, RBFR96210W	
STANDARD BI-METAL	4	6	152	634R		S234XF	DW4801	—	RC603	
	6	4	102	456RP		—	—	5052	RB606	
	6	6	152	636RP		RDW66	—	—	RB606P	
	6	6	152	656R		RDN6V, RHN66, RW66, RN66, RN96, RN126	DW4802, DW4802B, DW4847, DW4848B, DW4876	5031, 5035	RB63506, RB65006, RB65058, RC606	
	6	6	152	676RC		—	DW4816	5041	RB65006C	
	6	6	152	606R		—	DW4850	5012, 5015	RB606ST, RB658, RC606ST	
	6	9	229	956R		RPRW8, RDN9V, RSN9V, RHN96, RW96	DW4803, DW4803B, DW4848	5016, 5036	RB93506, RB95006, RC905, RC906	
	6	12	305	156R		RHN126, RW126	DW4804, DW4804B, DW4849	5017, 5037	RB123506, RB125006, RB125058ST, RB125058, RC1206	
	10	6	152	610R		RPRAP6, RAP610	DW4806, DW4806B, DW4845, DW4877	4091, 5090, 5091, 5092	RB610, RB65010, RBMC610, RC610	
	10	8	203	810R		RPRAP8, RAP810, RAP910	DW4865B	5093, 5175	RB810, RB8501014, RBMC810	
	10/14	6	152	635R		—	—	—	—	
	10/14	6	152	650R		RD6V, RRD6V, SRD6, RAP6V	DW4864, DW4864B	—	RB61014, RB6501014, RB6501014T	
	10/14	8	203	835R		—	—	5193	—	
	10/14	8	203	850R		RD9V, RRD9V, SRD9, RAP9V	DW4865	5193	RB81014, RB8501014	
	10/14	12	305	110R		RD12V, RRD12V, SRD12, RFM10V, SHMF10, RAP12V	DW4838	5094, 5194	RB121014, RB12501014, RB12501014ST, RB12501014	
	14	3-5/8	92	314RC		—	DW4814	5161, 5162	—	
	14	4	102	414R		—	DW4807, DW4807B	5181	RB414, RH414	
	14	6	152	614R		—	RM614	DW4808, DW4808B	5182, 5282, 4182	RB614, RB65014, RBMC614, RH614
	14	8	203	814R		—	RM914	—	5187, 4187	RB814, RBMC814
	14	9	225	9514R		—	—	—	—	
	18	3-5/8	92	318RC		—	RSM418	—	5163	RB318S, RH318S, RH324S
	18	4	102	418R		—	RS418	DW4810	5183	RB418, RH318, RH418
	18	6	152	618R		—	RS618, RM618	DW4811, DW4811B, DW4878	5184, 5284, 4184	RB618, RBMC618, RH618
	18	8	203	818R		—	RM918	DW4921	5188, 4188	RB814, RB818, RBMC818
	18	12	305	118R		—	RM1218	—	5189, 4189	RB1018, RB1218, RBMC1218
	24	4	102	424R		—	S518A, S518AF, S518AF-100, S518EF, S518G	DW4812	5185	RB424, RH424
	24	6	152	624R		—	RM624	DW4815	5186, 5286, 4186	RB624, RBMC624, RH624
	24	8	203	824R		—	RM924	—	—	—
	LENOX DIAMOND™	Grit	8	203	800DRDG		RCB8DG	—	1450	—
	CARBIDE GRIT	Grit	6	152	600RG		RCB6G	DW4844	1400, 1410, 1420	RTCG4, RTCG6
		Grit	8	203	800RG		RCB9G	DW4843	1430	RTCG8
		Grit	10	254	100RG		—	—	—	RTCT6065
CARBIDE TIPPED	3	8	203	8535RCT		—	—	—	RTCT6065	
	6	6	152	6565RCT		—	—	—	RCFP66	
	6	6	152	6563RCT		—	—	—	—	
FLEAM GROUND	6	6	152	6W6R		—	—	5015	—	
	6	9	229	9W6R		—	—	5016	—	



MASTER-BAND™ BLADES

Maximum Performance for Portable Band Saws

ENHANCED BEAM STRENGTH

Specially treated bands of .023 and .025 thicknesses offer increased blade strength, reducing deflection and twisting of blades during severe cutting conditions

SHATTER RESISTANT

Bi-metal blades bend and resist breaking and extend blade life

LONG LASTING

LENOX TUFF TOOTH design reinforces tooth for longer blade life



TPI	LENGTH X WIDTH X THICKNESS		EDGE MATERIAL	3-PACK PROD NO	25-PACK PROD NO	APPLICATION
	IN	MM				
10/14	44-7/8 x 1/2 x .023	1140 x 12.7 x .6	Matrix	8011438EW1014	9403B38EW1014	1/4" & larger, most metals
14	44-7/8 x 1/2 x .023	1140 x 12.7 x .6	Matrix	8011538EW14	9404B38EW14	3/16"– 3/8", most metals
14/18	44-7/8 x 1/2 x .023	1140 x 12.7 x .6	Matrix	8011238EW1418	9407B38EW1418	1/8"– 5/16", most metals
18	44-7/8 x 1/2 x .023	1140 x 12.7 x .6	Matrix	8011638EW18	9405B38EW18	3/32"– 1/4", most metals
24	44-7/8 x 1/2 x .023	1140 x 12.7 x .6	Matrix	8011738EW24	9406B38EW24	up to 1/8", most metals
8/12	44-7/8 x 1/2 x .025	1140 x 12.7 x .6	M42	80143385EW812	9398B385EW812	3/8"– 1/2", metals, including stainless steel
10/14	44-7/8 x 1/2 x .025	1140 x 12.7 x .6	M42	80144385EW1014	9399B385EW1014	1/4" & larger, metals, including stainless steel
14	44-7/8 x 1/2 x .025	1140 x 12.7 x .6	M42	80145385EW14	9400B385EW14	3/16"– 3/8", metals, including stainless steel
14/18	44-7/8 x 1/2 x .025	1140 x 12.7 x .6	M42	80142385EW1418	9401B385EW1418	1/8"– 5/16", metals, including stainless steel
18	44-7/8 x 1/2 x .025	1140 x 12.7 x .6	M42	82310385EW18	9402B385EW18	3/32"– 1/4", metals, including stainless steel

WOLF-BAND® BLADES

Professional Performance and Exceptional Value

LONG LASTING

High speed steel teeth provide a strong, long lasting cutting edge

SHATTER RESISTANT

Bi-metal blades bend and resist breaking and extend blade life

EXCEPTIONAL VALUE

Professional performance and competitive pricing provide extraordinary cost-per-cut value



TPI	LENGTH X WIDTH X THICKNESS		1-PACK PROD NO	5-PACK PROD NO	25-PACK PROD NO	APPLICATION
	IN	MM				
10/14	44-7/8 x 1/2 x .020	1140 x 12.7 x .5	3842838PW10141	8009838PW10145	3842338PW1014	1/4" & larger
14	44-7/8 x 1/2 x .020	1140 x 12.7 x .5	3842938PW141	8010738PW145	3842438PW14	3/16"– 3/8"
14/18	44-7/8 x 1/2 x .020	1140 x 12.7 x .5	3843038PW14181	8009938PW14185	3842738PW1418	1/8"– 5/16"
18	44-7/8 x 1/2 x .020	1140 x 12.7 x .5	3843138PW181	8010838PW185	3842538PW18	3/32"– 1/4"
24	44-7/8 x 1/2 x .020	1140 x 12.7 x .5	3843238PW241	8010938PW245	3842638PW24	up to 1/8"
COMPACT PORTABLE BAND SAW BLADES						
10/14	35-3/8 x 1/2 x .020	900 x 13 x .50	1786692	1786673	1786678	1/4" (6mm) & larger
14	35-3/8 x 1/2 x .020	900 x 13 x .50	1786693	1786674	1786679	3/16" (5mm)– 3/8" (10mm)
18	35-3/8 x 1/2 x .020	900 x 13 x .50	1786695	1786675	1786680	3/32" (2mm)– 1/4" (6mm)
24	35-3/8 x 1/2 x .020	900 x 13 x .50	1786660	1786676	1786761	up to 1/8" (3,2mm)



JIG SAW BLADES

Bi-metal.....	64
High Carbon Steel & LENOX <i>DIAMOND</i> [™] Grit	65
Carbide Grit, Jig Saw Blade Sets & Air Saw Blades	66
Metal Cutting Circular Saw Blades.....	67



BI-METAL JIG SAW BLADES

Ideal for Woodworking and Metal Cutting

PRECISION CUTTING

Super sharp to cut fast without deflection

SMOOTH FINISH

Ground to precision sharpness for straight cuts and a smooth finish

IDEAL FOR WOODWORKING

Designed for optimal performance in wood cutting, including hardwoods

SHATTER RESISTANT

Bi-metal technology flexes and resists breaking and extends blade life

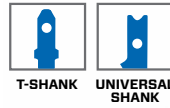

	TPI	LENGTH		T-SHANK	PROCESS	2-PACK PROD NO	5-PACK PROD NO	25-PACK PROD NO	APPLICATION	COMPETITIVE CROSS REFERENCE BOSCH®
		IN	MM							
WOOD CUTTING	6	4	102		Milled	20305BT406S	—	20812B406S	Fast, rough cut	T144DF
	6	4	102		Ground	20315BT456S	20850F456S	20781B456S	Very fast, clean cut	
	6	6	102		Milled	20309BT686S			Fast cut	
	10	4	102		Milled	20306BT410S	20851F410S	20813B410S	Fast, nail-embedded wood	T127DF
	10	4	102		Ground	20313BT450S	20842F450S	20814B450S	Clean, smooth cut	T101BF
	10D	4	102		Ground	20314BT450SR	20843F450SR	20782B450SR	Down cut	T101BRF
	20	3-1/4	82.5		Ground	20311BT320SC	—	—	Scroll cut, laminates	T101AOF
METAL CUTTING	14	3-5/8	92.1		Milled	20301BT314S	20832F314S	20815B314S	Thick metal	T188BF/T118B
	18	3-5/8	92.1		Milled	20302BT318S	20834F318S	20816B318S	Medium metal	T118EF
	18	5-1/4	133.4		Milled	20308BT518S	20854F518S	—	Medium metal	T318B
	24	3-5/8	92.1		Milled	20303BT324S	20835F324S	20817B324S	Thin metal	T118A/T118AF
	32	3-5/8	92.1		Milled	20803BT332S	—	—	Very thin metal	T118G
WOOD CUTTING	6	4	102		Milled	20329BT486J	20652F486J	—	Fast, rough cut	U111DF
	6	4	102		Ground	20337BT456J	—	20784B456J	Very fast, clean cut	U101DF
	6	6	102		Milled	20331BT686J	—	—	Fast cut	—
	10	4	102		Milled	20328BT480J	20654F480J	—	Fast, nail-embedded wood	—
	10	4	102		Ground	20335BT450J	20648F450J	20702B450J	Clean, smooth cut	U101BF
	10D	4	102		Ground	20336BT450JR	—	20791B450JR	Down cut	—
	20	2-3/4	69.9		Ground	20333BT320JC	—	—	Scroll cut, laminates	U1A0F
METAL CUTTING	14	3-5/8	92.1		Milled	20321BT314J	20641F314J	20705B314J	Thick metal	U118B/U118BF
	18	3-5/8	92.1		Milled	20322BT318J	20643F318J	20706B318J	Medium metal	U118E/U118EF
	18	5-1/4	133.4		Milled	20330BT518J	—	—	Medium metal	—
	24	3-5/8	92.1		Milled	20323BT324J	20644F324J	20707B324J	Thin metal	U118A/U118AF
	32	3-5/8	92.1		Milled	20609BT332J	—	—	Very thin metal	U118G/U118GF

BOSCH is a registered trademark of Robert Bosch Tool Corporation

HIGH CARBON STEEL JIG SAW BLADES

Ideal for Woodworking

PRECISION CUTTING

Super sharp to cut fast without deflection

SMOOTH FINISH

Ground to precision sharpness for straight cuts and a smooth finish

IDEAL FOR WOODWORKING

Designed for optimal performance in wood cutting, including hardwoods

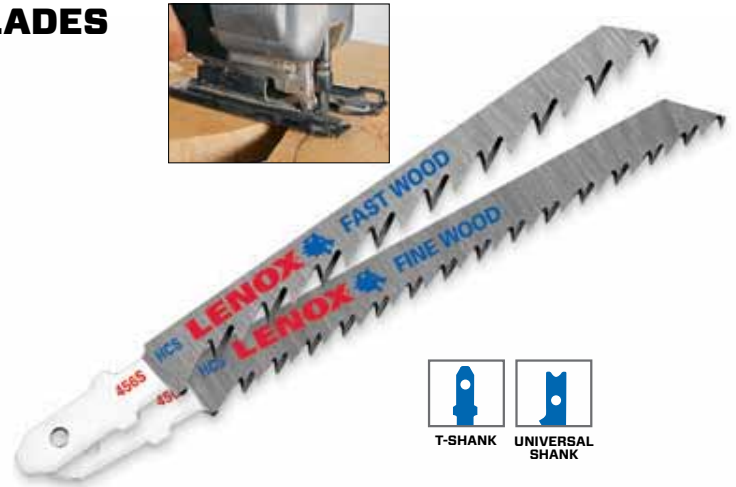

TPI	LENGTH		T-SHANK	PROCESS	2-PACK	5-PACK	25-PACK	APPLICATION	COMPETITIVE CROSS REFERENCE BOSCH®
	IN	MM			PROD NO	PROD NO	PROD NO		
6	4	102		Milled	20750CTS406S	20298CFS406S	—	Fast, rough cut	T111C
6	4	102		Ground	20751CT456S	20297CF456S	20292BC456S	Very fast, clean	T101D
6	3-5/8	92.1		Ground	20312CT416SC	—	—	Scroll cut	T244D
10	4	102		Ground	20752CT450S	20296CF450S	20291BC450S	Clean, smooth cut	T101B
10D	4	102		Ground	20753CT450SR	20295CF450SR	20290BC450SR	Down cut	T101BR
20	3-1/4	82.5		Ground	20754CT320SC	20299CF320SC	20294BC320SC	Scroll cut, laminates	T101A0

TPI	LENGTH		U-SHANK	PROCESS	2-PACK	5-PACK	25-PACK	APPLICATION	COMPETITIVE CROSS REFERENCE BOSCH®
	IN	MM			PROD NO	PROD NO	PROD NO		
6	4	102		Milled	20755CTS406J	—	—	Fast, rough cut	U111D
6	4	102		Ground	20756CT456J	—	20794BC456J	Very fast, clean cut	U101D
6	3-5/8	92.1		Ground	20334CT416JC	—	—	Scroll cut	U244D
10	4	102		Ground	20757CT450J	—	20795BC450J	Clean, smooth cut	U101B
10D	4	102		Ground	20758CT450JR	—	—	Down cut	U101BR
20	2-3/4	69.9		Ground	20759CT320JC	—	20797BC320JC	Scroll cut, laminates	U101A0

LENOX DIAMOND™ GRIT JIG SAW BLADE



TPI	LENGTH		T-SHANK	PROCESS	1-PACK	APPLICATION
	IN	MM			PROD NO	
Grit	3-1/2	88.9		Grit	12149	Ceramic Tile, Fiberglass



CARBIDE GRIT JIG SAW BLADES



TPI	LENGTH		SHAPE	PROCESS	2-PACK	5-PACK	APPLICATION	COMPETITIVE CROSS REFERENCE
	IN	MM	T-SHANK		PROD NO	PROD NO		BOSCH®
Grit	3-1/2	88.9		Grit	20300GT300S	20830F300SG	Ceramic Tile	T130RF3
U-SHANK								
Grit	3-1/2	88.9		Grit	20320GT300J	—	Ceramic Tile	—

BOSCH is a registered trademark of Robert Bosch Tool Corporation

JIG SAW BLADE SETS

Bi-Metal Sets



20868U743SA
7 PIECE T-SHANK
BI-METAL SET

456S, 450SR, 450S,
406S, 324S, 318S, 314S

VINYL POUCH



20606U743JA
7 PIECE U-SHANK
BI-METAL SET

456J, 450JR, 450J,
406J, 324J, 318J, 314J

VINYL POUCH

High Carbon Steel Sets



20764C543SA
5 PIECE T-SHANK
MULTI-PURPOSE SET

456S, 450S, 324S,
320SC, 318S

BLISTER PACK



20769C543JA
5 PIECE U-SHANK
MULTI-PURPOSE SET

456J, 450J, 324J,
320JC, 318J

BLISTER PACK

AIR SAW BLADES

Maximum Durability for Pneumatic Machine Cutting

SHATTER RESISTANT

Bi-metal blades bend and resist breaking and extend blade life

LONG LASTING

High speed steel teeth provide a strong, long lasting cutting edge



TPI	LENGTH X WIDTH X THICKNESS		5-PACK	25-PACK	APPLICATION
	IN	MM	PROD NO	PROD NO	
18	4 x 1/2 x .025	102 x 12.7 x .6	20426418T	20423B418T	For pneumatic machine cutting applications in automotive repair & sheet metal
24	4 x 1/2 x .025	102 x 12.7 x .6	20427424T	20424B424T	
32	4 x 1/2 x .025	102 x 12.7 x .6	20428432T	20425B432T	

METAL CUTTING CIRCULAR SAW BLADES

A Faster Way to Cut Metal™

EXTENDED LIFE

Titanium carbide tipped
Resists material build-up on teeth

CLEAN, COOL CUTS

Less burr than abrasive blades
No need for secondary grinding
Reduced material burning

MODIFIED TRIPLE CHIP GRIND

For added durability

RESHARPENABLE



	DIAMETER		PROD NO	TOOTH COUNT	RPM	ARBOR		APPLICATION
	IN	MM				IN	MM	
STEEL	5-3/8	135	21876ST538030CT	30	3500	—	20	Structurals Thick walled pipe Threaded rod Channel steel Plate Solid steel
	6-3/4	171	21878ST634040CT	40	5800	—	20	
	7	180	21879ST700038CT	38	4300	—	20	
	7-1/4	184	21881ST714040CT	40	5800	5/8	16	
	8	203	21884ST800050CT	50	5800	5/8	16	
	9	230	21885ST900048CT	48	5200	1	25.4	
	10	254	21886ST100052CT	52	5200	5/8	16	
	12	305	21888ST120060CT	60	1500	1	25.4	
THIN STEEL	14	355	21891ST140080CT	80	1800	1	25.4	Sheet metal Thin walled pipe Metal roofing Metal decking
	6-1/2	165	21877TS612048CT	48	5800	5/8	16	
	7	180	21880TS700068CT	68	4300	—	20	
	7-1/4	184	21883TS714068CT	68	5800	5/8	16	
	12	305	21890TS120080CT	80	1500	1	25.4	
ALUMINUM	14	355	21893TS140090CT	90	1800	1	25.4	Aluminum Copper Brass
	7-1/4	184	21882AL714060CT	60	5800	5/8	16	
	10	254	21887AL100080CT	80	5200	5/8	16	
	12	305	21889AL120080CT	80	4000	1	25.4	
	14	355	21892AL140080CT	80	3000	1	25.4	



LEWIS METAL

21



HOLE SAWS

Bi-metal <i>SPEED SLOT</i> [®] Hole Saws	70
<i>SNAP-BACK</i> [™] Arbors & Quick Change Extensions.....	72
Standard Arbors & Accessories.....	73
Bi-metal Kits.....	74
Carbide Tipped & Kits.....	75
Carbide Grit & Kits	77
<i>LENOX</i> [®] <i>DIAMOND</i> [™]	78
Carbide Hole Cutters & <i>LENOX PROTOOL LUBE</i> [®]	79
<i>ONE TOOTH</i> [®] Rough Wood Hole Cutters	80
Carbide Grit Recessed Lighting & Hole Saw Selection Guide	81
Recommended Hole Saw RPM.....	82



BI-METAL SPEED SLOT® HOLE SAWS

Long Lasting, Fast Cutting and Versatile

PLUG REMOVAL AS EASY AS 1-2-3

SPEED SLOT features a staircase design for easy plug removal

UP TO 2X LIFE IN METAL CUTTING

Enhanced tooth geometry, a thin kerf design, and an advanced coating contribute to the efficiency of the cutting process



DIAMETER		1 PER BOX	1 PER BLISTER SEAL	1 PACK ARBORED	PIPE TAP		PIPE ENTRANCE		USE ARBOR	
IN	MM	PROD NO	PROD NO	PROD NO	IN	MM	IN	MM	SNAP-BACK™	STANDARD
9/16	14.3	300099L	1787781	1772423	—	—	—	—	5L	1L, 4L or 5L
5/8	15.9	3001010L	1771823	1772424	—	—	—	—	5L	1L, 4L or 5L
11/16	17.5	3001111L	1787773	1772425	—	—	—	—	5L	1L, 4L or 5L
3/4	19.1	3001212L	1771952	1772426	1/2	12.7	3/8	9.5	5L	1L, 4L or 5L
25/32	19.8	3009820MMHS	1771962	1772427	—	—	—	—	5L	1L, 4L or 5L
13/16	20.6	3001313L	1787775	1772428	—	—	—	—	5L	1L, 4L or 5L
7/8	22.2	3001414L	1771953	1772429	3/4	19.1	1/2	12.7	5L	1L, 4L or 5L
15/16	23.8	3001515L	1787776	1772430	—	—	—	—	5L	1L, 4L or 5L
1	25.4	3001616L	1771954	1772481	—	—	—	—	5L	1L, 4L or 5L
1-1/16	27.0	3001717L	1771955	1772482	—	—	—	—	5L	1L, 4L or 5L
1-1/8	28.6	3001818L	1771959	1772483	1	25.4	3/4	19.1	5L	1L, 4L or 5L
1-3/16	30.2	3001919L	1787777	1772474	—	—	—	—	5L	1L, 4L or 5L
1-1/4	31.8	3002020L	1771960	1772491	—	—	—	—	2L, 6L	2L, 3L or 6L
1-5/16	33.3	3002121L	1787778	1772492	—	—	—	—	2L, 6L	2L, 3L or 6L
1-3/8	34.9	3002222L	1771961	1772727	—	—	1	25.4	2L, 6L	2L, 3L or 6L
1-7/16	36.5	3002323L	1787779	1772728	—	—	—	—	2L, 6L	2L, 3L or 6L
1-1/2	38.1	3002424L	1771963	1772729	1-1/4	31.8	—	—	2L, 6L	2L, 3L, 6L or 7L
1-9/16	39.7	3002525L	1787780	1772730	—	—	—	—	2L, 6L	2L, 3L, 6L or 7L
1-5/8	41.3	3002626L	1771964	1772931	—	—	—	—	2L, 6L	2L, 3L, 6L or 7L
1-11/16	42.9	3002727L	1787800	1772932	—	—	—	—	2L, 6L	2L, 3L, 6L or 7L
1-3/4	44.5	3002828L	1771967	1772933	1-1/2	38.1	1-1/4	31.8	2L, 6L	2L, 3L, 6L or 7L
1-13/16	46.0	3002929L	1787841	1772935	—	—	—	—	2L, 6L	2L, 3L, 6L or 7L
1-7/8	47.6	3003030L	1771968	1772778	—	—	—	—	2L, 6L	2L, 3L, 6L or 7L
2	50.8	3003232L	1771970	1772779	—	—	1-1/2	38.1	2L, 6L	2L, 3L, 6L or 7L
2-1/16	52.4	3003333L	1787842	1772780	—	—	—	—	2L, 6L	2L, 3L, 6L or 7L
2-1/8	54.0	3003434L	1772003	1772951	—	—	—	—	2L, 6L	2L, 3L, 6L or 7L
2-1/4	57.2	3003636L	1771983	1772952	2	50.8	—	—	2L, 6L	2L, 3L, 6L or 7L
2-3/8	60.3	3003838L	1771984	1772953	—	—	—	—	2L, 6L	2L, 3L, 6L or 7L
2-1/2	63.5	3004040L	1771987	1772954	—	—	2	50.8	2L, 6L	2L, 3L, 6L or 7L
2-9/16	65.1	3004141L	1787843	1772955	—	—	—	—	2L, 6L	2L, 3L, 6L or 7L
2-5/8	66.7	3004242L	1771988	1772956	2-1/2	63.5	—	—	2L, 6L	2L, 3L, 6L or 7L
2-11/16	68.3	3004343L	1771989	—	—	—	—	—	2L, 6L	2L, 3L, 6L or 7L



DIAMETER		1 PER BOX	1 PER BLISTER SEAL	1 PACK ARBORED	PIPE TAP		PIPE ENTRANCE		USE ARBOR	
IN	MM	PROD NO	PROD NO	PROD NO	IN	MM	IN	MM	SNAP-BACK	STANDARD
2-3/4	69.9	3004444L	1771990	1772961	—	—	—	—	2L, 6L	2L, 3L, 6L or 7L
2-7/8	73.0	3004646L	1787844	1772962	—	—	—	—	2L, 6L	2L, 3L, 6L or 7L
3	76.2	3004848L	1772021	1772963	—	—	2-1/2	63.5	2L, 6L	2L, 3L, 6L or 7L
3-1/8	79.4	3005050L	1772022	1772964	—	—	—	—	2L, 6L	2L, 3L, 6L or 7L
3-1/4	82.6	3005252L	1772023	1772966	3	76.2	—	—	2L, 6L	2L, 3L, 6L or 7L
3-3/8	85.7	3005454L	1787845	1772945	—	—	—	—	2L, 6L	2L, 3L, 6L or 7L
3-1/2	88.9	3005656L	1772012	1772946	—	—	—	—	2L, 6L	2L, 3L, 6L or 7L
3-5/8	92.1	3005858L	1772013	1772949	—	—	3	76.2	2L, 6L	2L, 3L, 6L or 7L
3-3/4	95.3	3006060L	1787846	1772950	3-1/2	85.7	—	—	2L, 6L	2L, 3L, 6L or 7L
3-7/8	98.4	3006262L	1787847	1773001	—	—	—	—	2L, 6L	2L, 3L, 6L or 7L
4	101.6	3006464L	1772014	1773002	—	—	—	—	2L, 6L	2L, 3L, 6L or 7L
4-1/8	104.8	3006666L	1772018	1773003	—	—	3-1/2	85.7	2L, 6L	2L, 3L, 6L or 7L
4-1/4	108.0	3006868L	1772019	1773004	4	95.3	—	—	2L, 6L	2L, 3L, 6L or 7L
4-3/8	111.1	3007070L	1787848	1773005	—	—	—	—	2L, 6L	2L, 3L, 6L or 7L
4-1/2	114.3	3007272L	1772075	1773006	—	—	—	—	2L, 6L	2L, 3L, 6L or 7L
4-5/8	117.5	3007474L	1787850	—	—	—	4	95.3	2L, 6L	2L, 3L, 6L or 7L
4-3/4	120.7	3007676L	1772076	1773008	4-1/2	108.0	—	—	2L, 6L	2L, 3L, 6L or 7L
5	127.0	3008080L	1772077	—	—	—	—	—	2L, 6L	2L, 3L, 6L or 7L
5-1/2	139.7	3008888L	1787785	—	—	—	—	—	2L, 6L	2L, 3L, 6L or 7L
6	152.4	3009696L	1772121	—	—	—	—	—	2L, 6L	2L, 3L, 6L or 7L

CONTRACTOR'S HOLE SAW 5 PACKS

VALUE & CONVENIENCE

Unique packaging provides value and convenience for high volume users

PROD NO	IN	MM
10735B14L	7/8	22.2
10736B16L	1	25.4
10737B18L	1-1/8	28.6
10738B20L	1-1/4	31.8
10739B22L	1-3/8	34.9
10740B24L	1-1/2	38.1
10741B28L	1-3/4	44.5
10742B32L	2	50.8





SNAP-BACK™ ARBORS

No Tools. No Adaptors. No Screwing Around.

QUICK CHANGE

Faster and easier to engage/disengage hole saw

PREVENTS THREADS FROM STRIPPING

Drives off pins, not threads

NO TOOLS NEEDED

Prevents hole saw from locking on arbor

NO ADAPTOR REQUIRED

Arbor threads directly into all hole saws

EASIER PLUG REMOVAL



PROD NO	DESC	FITS HOLE SAWS	SIZES		THREAD SIZE	SHANK TYPE	SHANK SIZE	
			IN	MM			IN	MM
1779772	2L	20L-96L	1-1/4-6	31.8-152.4	5/8-18	Solid Hex	1/2 & larger	12.7 & larger
1779669	5L	9L-19L	9/16-1-3/16	14-30	1/2-20	Solid Hex	3/8 & larger	9.5 & larger
1779670	6L	20L-96L	1-1/4-6	31.8-152.4	5/8-18	Solid Hex	3/8 & larger	9.5 & larger

Solid Hex



2L



5L



6L

SNAP-BACK QUICK CHANGE EXTENSIONS

DURABILITY AND EXTENDED LIFE

Carbon steel collar and shaft for durability and extended life

ONE-HANDED RELEASE

SNAP-BACK™ Quick Change mechanism for quick and easy release

BIT HELD SECURELY IN PLACE

Patented jaw design holds bits securely on 6-flatted shanks and ball detent bits



1852050

1852047

1852048

1852049

PROD NO	IN	MM	CHUCK SIZE		FITS ARBOR	
			IN	MM	SNAP-BACK	STANDARD
1852050	5-1/2	140	7/16	11	2L	1L, 2L, 3L
1852047	12	305	3/8	9.5	5L, 6L	5L, 6L, 7L
1852048	12	305	7/16	11	2L	1L, 2L, 3L
1852049	18	457	7/16	11	2L	1L, 2L, 3L

STANDARD ARBORS & ACCESSORIES

Arbors & Accessories for All Your Drilling Needs

ADDED DURABILITY

Hardened carbon steel for strength

STARTS ON CONTACT

Split point pilot drill for faster penetration and less walking



LENOX 6L Arbor with quick change feature (product no 1779805)

PROD NO	DESC	FITS HOLE SAWS	SIZES		SHANK TYPE	SHANK SIZE		PRIMARY FEATURE
			IN	MM		IN	MM	
1779774	1L	9L-19L	9/16-1-3/16	14.3-30.2	Hollow Hex	1/2 & larger	12.7 & larger	Adjustable pilot bit
1779801	2L	20L-96L	1-1/4-6	31.8-152.4	Solid Hex	1/2 & larger	12.7 & larger	Use for enlarging holes
1856058	2L	20L-96L	1-1/4-6	31.8-152.4	Hollow Hex	1/2 & larger	12.7 & larger	Use for enlarging holes, adjustable pilot bit
1779802	3L	20L-96L	1-1/4-6	31.8-152.4	Solid Hex	1/2 & larger	12.7 & larger	Solid shank
1779803	4L	9L-19L	9/16-1-3/16	14.3-30.2	3 Sided	1/4 & larger	6.4 & larger	Adjustable pilot bit, 3 flats on shank
1779804	5L	9L-19L	9/16-1-3/16	14.3-30.2	Hex	3/8 & larger	9.5 & larger	Use for 9A-19A arbored hole saws
1779805	6L	20L-96L	1-1/4-6	31.8-152.4	Hex	3/8 & larger	9.5 & larger	Quick change arbor
1779806	7L	24L-96L	1-1/2-6	31.8-152.4	Hex	3/8 & larger	9.5 & larger	Plug ejection feature

PROD NO	DESCRIPTION	CHUCK SIZE		SNAP BACK	FITS ARBOR	
		IN	MM		SOLID HEX	HOLLOW HEX
1779771	4-1/4" Pilot Drill (1 pack)	1/4	6.4	—	1L, 4L	2L
1779841	4-1/4" Pilot Drill (25 pack)	1/4	6.4	—	1L, 4L	2L
1779810	3-1/4" Pilot Drill (1 pack)	1/4	6.4	2L, 5L, 6L	2L, 3L, 5L, 6L, 7L	—
1864904	3-1/4" Pilot Drill (25/pack)	1/4	6.4	2L, 5L, 6L	2L, 3L, 5L, 6L, 7L	—
30297123CT	Carbide Tipped Pilot Drill (1 pack)	1/4	6.4	—	1L, 4L	2L
3029865CTPD	Carbide Tipped Pilot Drill (1pack)	1/4	6.4	2L, 5L, 6L	2L, 3L, 5L, 6L, 7L	—
30857AA1	Arbor Adaptor (1 pack)	—	—	5L	1L, 4L, 5L	—
3084818X	18" Extension (1 pack)	1/2 & larger	12.7 & larger	2L	1L, 2L, 3L	2L
3084712 X	12" Extension (1 pack)	1/2 & larger	12.7 & larger	2L	1L, 2L, 3L	2L
3084310X*	10" Extension (1 pack)	3/8 & larger	9.5 & larger	5L, 6L	5L, 6L, 7L	—
3084655X	5-1/2" Extension (1 pack)	1/2 & larger	12.7 & larger	2L	1L, 2L, 3L	2L
2910114	1/4" x 1/4" Set Screw	—	—	2L, 5L, 6L	2L, 3L, 5L, 6L, 7L	2L
29102516	5/16" x 5/16" Set Screw	—	—	—	1L, 4L, Extension	—

* Fits arbored hole saws

ACCESSORIES





BI-METAL HOLE SAW KITS

Convenient Storage for Trade-Specific Uses

DURABLE

Durable construction resists damage caused by drops and tough workplace environments

SECURE

Latches close case tightly and securely. Lockable with standard padlocks

LONG LASTING

Metal latches and metal pin hinges won't break or tear



LARGE KIT
10\"/>

MEDIUM KIT
8\"/>

COMPACT KIT
4-11/16\"/>

MINI KIT
9\"/>



CONTRACTOR'S KITS



30370400G
5 PIECE KIT
2\", 3\", 3-3/8\", 4-1/8\"/>
SNAP-BACK Arbor: 2L
LARGE KIT



308201200G
17 PIECE KIT
5/8\", 3/4\", 7/8\", 1\", 1-1/8\", 1-1/4\",
1-3/8\", 1-1/2\", 1-3/4\",
2\", 2-1/2\", 3\"/>
SNAP-BACK Arbor: 2L
Arbor: 1L. Three pilot drills
LARGE KIT



30374500G
9 PIECE KIT
2-1/8\", 2-9/16\", 3-1/4\", 3-3/4\", 4-3/4\"/>
SNAP-BACK Arbor: 2L
Three pilot drills
LARGE KIT



308042000G
26 PIECE KIT-BIG DADDY™
3/4\", 7/8\", 1\", 1-1/8\", 1-3/8\", 1-1/2\",
1-3/4\", 2\", 2-1/8\", 2-1/4\", 2-1/2\",
2-11/16\", 3\", 3-1/4\", 3-3/8\", 3-5/8\",
3-3/4\", 4-1/8\", 4-1/2\", 4-3/4\"/>
SNAP-BACK Arbors: 2L, 5L
Arbor: 1L. Three pilot drills
LARGE KIT



30807700G
9 PIECE KIT
7/8\", 1\", 1-1/4\", 1-3/8\",
1-1/2\", 1-3/4\", 2-1/8\"/>
SNAP-BACK Arbors: 5L, 6L
MEDIUM KIT



1815140
7 PIECE KIT
7/8\", 1-1/8\", 1-3/8\", 1-1/2\", 2\"/>
SNAP-BACK Arbors: 2L, 5L
MINI KIT

ELECTRICIAN'S KITS



30856C600L
9 PIECE KIT
 7/8", 1-1/8", 1-3/8", 1-3/4", 2", 2-1/2"
SNAP-BACK Arbors: 2L, 5L
 One arbor adaptor
MEDIUM KIT



30800600L
10 PIECE KIT
 7/8", 1-1/8", 1-3/8", 1-3/4", 2", 2-1/2"
SNAP-BACK Arbors: 2L, 5L
 One pilot drill
 One arbor adaptor
LARGE KIT



308021200L
17 PIECE KIT
 3/4", 7/8", 1-1/8", 1-3/8", 1-3/4", 2",
 2-1/2", 2-11/16", 3", 3-5/8", 4-1/8", 4-3/4".
SNAP-BACK Arbors: 2L, 5L
 Three pilot drills
LARGE KIT



1815139
8 PIECE KIT
 7/8", 1-1/8", 1-3/8", 1-3/4", 2", 2-1/2"
SNAP-BACK Arbors: 2L, 5L
MINI KIT

PLUMBER'S KITS



30860C600P
9 PIECE KIT
 3/4", 7/8", 1-1/8", 1-3/8", 2", 2-1/2"
SNAP-BACK Arbors: 2L, 5L
 One arbor adaptor
MEDIUM KIT



30808600P
10 PIECE KIT
 3/4", 7/8", 1-1/8", 1-1/2", 1-3/4", 2-1/4"
SNAP-BACK Arbors: 2L, 5L
 One pilot drill
 One arbor adaptor
LARGE KIT



1853786
10 PIECE KIT
 2-1/8", 2-1/4", 2-9/16", 2-3/4",
 3-5/8", 4", 4-5/8"
SNAP-BACK Arbor: 2L
 Two pilot drills
LARGE KIT



308011200P
17 PIECE KIT
 3/4", 7/8", 1-1/8", 1-1/2", 1-3/4", 2-1/4",
 2-9/16", 3", 3-1/2", 4", 4-1/4", 4-1/2"
SNAP-BACK Arbors: 2L, 5L
 Three pilot drills
LARGE KIT



1815195
7 PIECE KIT
 1-1/4", 1-3/8", 1-1/2", 2", 2-1/2"
SNAP-BACK Arbors: 2L, 5L
MINI KIT

REFRIGERATION KIT



30830600R
8 PIECE KIT
 5/8", 7/8", 1-1/8"
 1-3/8", 1-5/8", 2-1/8"
SNAP-BACK Arbors: 5L, 6L
MEDIUM KIT

WELDER'S KIT



14789600W
9 PIECE KIT
 3/4", 7/8", 1", 1-1/4",
 1-1/2", 2"
SNAP-BACK Arbors:
 2L, 5L
 One arbor adaptor
MEDIUM KIT

AUTOMOTIVE KIT



30805500A
7 PIECE KIT
 3/4", 7/8", 1",
 1-1/8", 1-1/4"
 Arbor: 5L
 One arbor adaptor
COMPACT KIT



CARBIDE TIPPED HOLE SAWS

Designed for Cutting Tile and Stainless Steel

LONG TOOL LIFE

Heat resistant carbide teeth for long life in tile and stainless steel

ADDED DURABILITY

Thick backing plate resists damage and increases life

UNIQUE TOOTH CONFIGURATION

Engineered design provides ability to cut in stainless steel like no other

USE STANDARD ARBOR OR SNAP-BACK™ ARBOR



1 PER PACK PROD NO	DIAMETER		PIPE TAP		PIPE ENTRANCE		USE ARBOR	
	IN	MM	IN	MM	IN	MM	SNAP-BACK	STANDARD
3021111CT	11/16	17.5	—	—	—	—	5L	1L, 4L, 5L
3021212CT	3/4	19.1	1/2	12.7	3/8	9.5	5L	1L, 4L, 5L
3021414CT	7/8	22.2	3/4	19.1	1/2	12.7	5L	1L, 4L, 5L
3021616CT	1	25.4	—	—	—	—	5L	1L, 4L, 5L
3021818CT	1-1/8	28.6	1	25.4	3/4	19.1	5L	1L, 4L, 5L
3022020CT	1-1/4	31.8	—	—	—	—	2L	2L, 3L, 6L
3022222CT	1-3/8	34.9	—	—	1	25.4	2L	2L, 3L, 6L
3022424CT	1-1/2	38.1	1-1/4	31.8	—	—	2L	2L, 3L, 6L, 7L
3022626CT	1-5/8	41.3	—	—	—	—	2L	2L, 3L, 6L, 7L
3022828CT	1-3/4	44.5	1-1/2	38.1	1-1/4	31.8	2L	2L, 3L, 6L, 7L
3023232CT	2	50.8	—	—	1-1/2	38.1	2L	2L, 3L, 6L, 7L
3023434CT	2-1/8	54.0	—	—	—	—	2L	2L, 3L, 6L, 7L
3023636CT	2-1/4	57.2	2	50.8	—	—	2L	2L, 3L, 6L, 7L
3023838CT	2-3/8	60.3	—	—	—	—	2L	2L, 3L, 6L, 7L
3024040CT	2-1/2	63.5	—	—	2	50.8	2L	2L, 3L, 6L, 7L
3024141CT	2-9/16	65.1	—	—	—	—	2L	2L, 3L, 6L, 7L
3024242CT	2-5/8	66.7	2-1/2	63.5	—	—	2L	2L, 3L, 6L, 7L
3024343CT	2-11/16	68.3	—	—	—	—	2L	2L, 3L, 6L, 7L
3024848CT	3	76.2	—	—	2-1/2	63.5	2L	2L, 3L, 6L, 7L
3025252CT	3-1/4	82.6	3	76.2	—	—	2L	2L, 3L, 6L, 7L
3025454CT	3-3/8	85.7	—	—	—	—	2L	2L, 3L, 6L, 7L
3025656CT	3-1/2	88.9	—	—	—	—	2L	2L, 3L, 6L, 7L
3025858CT	3-5/8	92.1	—	—	3	76.2	2L	2L, 3L, 6L, 7L
3026060CT	3-3/4	95.3	3-1/2	88.9	—	—	2L	2L, 3L, 6L, 7L
3026464CT	4	101.6	—	—	—	—	2L	2L, 3L, 6L, 7L
3026666CT	4-1/8	104.8	—	—	3-1/2	88.9	2L	2L, 3L, 6L, 7L
3026868CT	4-1/4	108.0	4	101.6	—	—	2L	2L, 3L, 6L, 7L
3027272CT	4-1/2	114.3	—	—	—	—	2L	2L, 3L, 6L, 7L
3027676CT	4-3/4	120.7	4-1/2	114.3	4	101.6	2L	2L, 3L, 6L, 7L
3028080CT	5	127.0	—	—	—	—	2L	2L, 3L, 6L, 7L
3028888CT	5-1/2	139.7	—	—	—	—	2L	2L, 3L, 6L, 7L
3029696CT	6	152.4	—	—	—	—	2L	2L, 3L, 6L, 7L

Recommended RPM for each Carbide Tipped Hole Saw on page 82

Note: We recommend the use of a carbide tipped pilot drill when cutting ceramic wall tile.

Pilot drill 123CT fits the SNAP-BACK 2L or standard arbors 1L, 2L, 4L or 7L. Pilot drill 65CTPD fits the SNAP-BACK 2L or standard arbors 5L and 6L. See pages 72-73.

PLUMBER'S KIT



30294600CTP
8 PIECE

3/4", 7/8", 1-1/8", 1-1/2",
1-3/4", 2-1/4"
SNAP-BACK Arbor: 2L
Arbor: 1L

MEDIUM KIT

ELECTRICIAN'S KIT



30295600CTL
8 PIECE

7/8", 1-1/8", 1-3/8", 1-3/4",
2", 2-1/2"
SNAP-BACK Arbor: 2L
Arbor: 1L

MEDIUM KIT

CONTRACTOR'S KIT



302901100CTG
15 PIECE

3/4", 7/8", 1", 1-1/8", 1-1/4",
1-3/8", 1-1/2", 1-3/4", 2",
2-9/16", 3"
SNAP-BACK Arbor: 2L
Arbor: 1L
Two pilot drills

LARGE KIT

CARBIDE GRIT HOLE SAWS

Best for Cutting Abrasive Materials

CUTS ABRASIVE MATERIALS

Tungsten carbide grit cuts through fiberglass, ceramic tile, laminates and other abrasive materials

CLEAN CUTTING

Carbide grit edge will not snag or chip when cutting thin materials

USE STANDARD ARBOR OR SNAP-BACK™ ARBOR



1 PER BOX PROD NO	DIAMETER		PIPE TAP		PIPE ENTRANCE		USE ARBOR	
	IN	MM	IN	MM	IN	MM	SNAP-BACK	STANDARD
2991212CG	3/4	19.1	1/2	12.7	3/8	9.5		1L, 4L
2999820MMCG	25/32	19.8	—	—	—	—		1L, 4L
2991414CG	7/8	22.2	3/4	19.1	1/2	12.7		1L, 4L
2991616CG	1	25.4	—	—	—	—		1L, 4L
2991818CG	1-1/8	28.6	1	25.4	3/4	19.1		1L, 4L
2992020CG	1-1/4	31.8	—	—	—	—	2L	2L
2992222CG	1-3/8	34.9	—	—	1	25.4	2L	2L
2992424CG	1-1/2	38.1	1-1/4	31.8	—	—	2L	2L, 7L
2992828CG	1-3/4	44.5	1-1/2	38.1	1-1/4	31.8	2L	2L, 7L
2993232CG	2	50.8	—	—	1-1/2	38.1	2L	2L, 7L
2993434CG	2-1/8	54	—	—	—	—	2L	2L, 7L
2993636CG	2-1/4	57.2	2	50.8	—	—	2L	2L, 7L
2993838CG	2-3/8	60.3	—	—	—	—	2L	2L, 7L
2994040CG	2-1/2	63.5	—	—	2	50.8	2L	2L, 7L
2994141CG	2-9/16	65.1	—	—	—	—	2L	2L, 7L
2994848CG	3	76.2	—	—	2-1/2	63.5	2L	2L, 7L
2995252CG	3-1/4	82.6	3	76.2	—	—	2L	2L, 7L
2995858CG	3-5/8	92.1	—	—	3	76.2	2L	2L, 7L
2996464CG	4	101.6	—	—	—	—	2L	2L, 7L
2996666CG	4-1/8	104.8	—	—	3-1/2	88.9	2L	2L, 7L

PLUMBER'S KIT



29984600CGP

9 PIECE

3/4", 7/8", 1-1/8", 1-1/2",
2-1/8", 2-9/16"
SNAP-BACK Arbor: 2L
Arbor: 1L. One arbor adaptor

MEDIUM KIT

CONTRACTOR'S KIT



29985700CGK

10 PIECE

7/8", 1", 1-1/4", 1-3/8", 1-1/2",
1-3/4", 2-1/8"
SNAP-BACK Arbor: 2L
Arbor: 1L. One arbor adaptor

MEDIUM KIT



LENOX DIAMOND™ HOLE SAWS

More Holes. Less Time.

ONE PIECE HOLE SAWS

LONG LASTING

Continuous, brazed edge lasts longer in tile and stone

FAST, EASY CUTTING

Low torque, little pressure required

EASIER PLUG REMOVAL

Over-sized slot in hole saw for easy plug removal

1 PER PACK PROD NO	IN	MM	PIPE TAP		PIPE ENTRANCE	
			IN	MM	IN	MM
121063DGDS	3/16	5				
121074DGDS	1/4	6				
121085DGDS	5/16	8				
121096DGDS	3/8	10				
121108DGDS	1/2	13				
1211110DGDS	5/8	16				
1211212DGDS	3/4	19	3/4	13	3/8	10
1211416DGDS	1	25				
1211622DGDS	1-3/8	35			1	25
12158DGDS4A	4 pc kit*					

* Sizes: 3/16", 1/4", 5/16", 3/8"



Diamond Edge



Easier Plug Removal



No Arbor Needed



1856785 10 PIECE KIT

1/4", 3/4", 7/8", 1-1/8", 1-3/8",
2", 2-1/2"

SNAP-BACK Arbors: 2L, 5L
Hex Wrench

LARGE KIT

STANDARD HOLE SAWS

LONG LASTING

Brazed diamond edge for more holes in tile and stone

DURABLE

Robust design for greater durability in tough applications

FAST CUTTING

Cuts holes in less time than carbide grit or carbide tipped hole saws

EASIER PLUG REMOVAL

Round holes make removing plugs faster and easier

USE STANDARD ARBOR OR SNAP-BACK™ ARBOR

1 PER PACK PROD NO	IN	MM	PIPE TAP		PIPE ENTRANCE		USE ARBOR	
			IN	MM	IN	MM	SNAP-BACK	STANDARD
1211314DGHS	7/8	22	3/4	19	1/2	13	5L	1L, 4L, 5L
1225618DGHS	1-1/8	29	1	25	3/4	19	5L	1L, 4L, 5L
1211520DGHS	1-1/4	32					2L, 6L	2L, 3L, 6L
1211722DGHS	1-3/8	35			1	25	2L, 6L	2L, 3L or 6L
1211824DGHS	1-1/2	38	1-1/4	32			2L, 6L	2L, 3L, 6L, 7L
1211932DGHS	2	51			1-1/2	38	2L, 6L	2L, 3L, 6L, 7L
1212040DGHS	2-1/2	64			2	51	2L, 6L	2L, 3L, 6L, 7L



Diamond Edge



Easier Plug Removal

CARBIDE HOLE CUTTERS

Designed Specifically for Sheet Metal Hole Cutting

ACCURATE, BURR-FREE HOLES

Precision ground carbide teeth for fast cutting of clean, round holes

WILL NOT DAMAGE WORK

Over-drill stopper prevents the tool from penetrating beyond the hole

STARTS ON CONTACT

Split point pilot bit for faster penetration and less walking



1 PER BOX PROD NO	DIAMETER		CONDUIT	USE ARBOR	
	IN	MM	SIZE	SNAP-BACK	STANDARD
2009212CHC	3/4	19.1	3/8"	5L	5L
2009314CHC	7/8	22.2	1/2"	5L	5L
2009416CHC	1	25.4	—	5L	5L
2009618CHC	1-1/8	28.6	3/4"	5L	5L
20097195CHC	1-7/32	30.9	—	5L	5L
2009820CHC	1-1/4	31.8	—	—	3L, 6L
2010022CHC	1-3/8	34.9	1"	—	3L, 6L
2010224CHC	1-1/2	38.1	—	—	3L, 6L
2010328CHC	1-3/4	44.5	1-1/4"	—	3L, 6L
2010432CHC	2	50.8	1-1/2"	—	3L, 6L
2010534CHCt	2-1/8	54.0	—	—	3L, 6L
2010840CHC	2-1/2	63.5	2"	—	3L, 6L
2010942CHC	2-5/8	66.7	—	—	3L, 6L
2011344CHC	2-3/4	69.9	—	—	3L, 6L
2011448CHC	3	76.2	2-1/2"	—	3L, 6L

ACCESSORIES

PROD NO	DESCRIPTION
3087935PD	1/4" Split point stubby pilot bit
308803CHCAS	Plug ejection springs
300033L	3L, 1/2" Arbor for 20CHC – 48CHC. Solid hex shank
300055L	5L, 3/8" Arbor for 11CHC – 19.5CHC. Solid hex shank
12203K5LSC	5L SNAP-BACK Arbor

ELECTRICIAN'S KITS



30877300CHC 12 PIECE KIT

7/8", 1-1/8", 1-3/8". Arbors: 3L, 5L
1/4" split point pilot bit. Plug ejection
springs, 1/8" hex wrench

COMPACT KIT



30878500CHC 15 PIECE KIT

7/8", 1-1/8", 1-3/8", 1-3/4", 2", 2-1/2"
Arbors: 3L, 5L. 1/4" split point pilot bit
Plug ejection springs, 1/8" hex wrench

MEDIUM KIT



LENOX PROTOOL LUBE®

Extends Tool Life

SHORTENS CUTTING TIME BY UP TO 50%

Provides smoother, cleaner cutting and
dramatically longer tool life

REDUCES HEAT AND FRICTION

Water soluble, so it cleans up with water

Biodegradable and non-toxic

PROD NO	CONTAINER SIZE		CONTAINERS PER CASE
	GALLON	LITER	
68040LNX	6 oz	.17	12
68047	1	3.8	4
68048	5	18.9	—
68050	55	208.2 drum	—

NFPA CODE SPECS

HMIS/WHMIS
HEALTH INDEX – 1
FLAMMABILITY – 0
REACTIVITY – 0
PERSONAL PROTECTION – A



Use this product as it comes from the container—do not mix with water.
MSDS available in hard copy or downloadable from lenoxtools.com



ONE TOOTH® ROUGH WOOD HOLE CUTTER

Drills Faster Than Self-Feed Bits

LONG LASTING

High speed steel tooth provides long tool life

CUTS FAST / LOW TORQUE

Designed to run at high speeds with very little torque

DURABLE WOOD CUTTING TOOL

Cuts wet, frozen, pressure treated and hard wood without binding

EASY PLUG REMOVAL

Patented design allows easy plug removal

CUTS AT AN ANGLE

Unique design provides the ability to cut at an angle

USE STANDARD ARBOR OR SNAP-BACK™ ARBOR

For optimal performance use a 3/8" Stubby Spade Bit with arbor



1 PER PACK PROD NO	CUTTER SIZE		CUTTING DEPTH		APPLICATION	USE ARBOR	
	IN	MM	IN	MM		SNAP-BACK	STANDARD
2542222HC	1-3/8	34.9	2-7/16"	62	1" pipe & lock installation	2L	2L, 3L
2543434HC	2-1/8	54.0	2-7/16"	62	1-1/2" pipe & lock installation	2L	2L, 3L
2543636HC	2-1/4	57.2	2-7/16"	62	1-1/2" pipe & 45°/90° bend couplings	2L	2L, 3L
2544141HC	2-9/16	65.1	2-7/16"	62	2" pipe	2L	2L, 3L
2544444HC	2-3/4	69.9	2-7/16"	62	2" pipe & 45°/90° bend couplings	2L	2L, 3L
2545454HC	3-3/8	85.7	2-7/16"	62	3" duct pipe & bendable duct pipe	2L	2L, 3L
2545656HC	3-5/8	92.1	2-7/16"	62	3" pipe	2L	2L, 3L
2546464HC	4	101.6	2-7/16"	62	3" pipe & coupling & dryer vent	2L	2L, 3L
2546969HC	4-5/16	109.5	2-7/16"	62	4" duct pipe & bendable duct pipe	2L	2L, 3L
2547474HC	4-5/8	117.5	2-7/16"	62	4" pipe	2L	2L, 3L
2548080HC	5	127.0	2-7/16"	62	4" pipe & coupling	2L	2L, 3L
2548787HC	5-1/2	139.7	2-7/16"	62	Toilet flange	2L	2L, 3L
2550000HC	6-1/4	158.8	2-7/16"	62	6" duct pipe	2L	2L, 3L
25310SB38	—	—	—	—	3/8" stubby spade bit	2L	2L, 3L
25312DIAF1	—	—	—	—	Diamond file for re-sharpening		



25476301G 7 PIECE

2-1/8", 2-9/16", 3-5/8"
SNAP-BACK Arbor: 2L, Diamond file
Two 3/8" stubby spade bits

LARGE KIT



25477701G 11 PIECE

2-1/8", 2-1/4", 2-9/16", 2-3/4",
3-5/8", 4", 4-5/8"
SNAP-BACK Arbor: 2L, Diamond file
Two 3/8" stubby spade bits

LARGE KIT

CARBIDE GRIT RECESSED LIGHTING HOLE SAWS

Best for Cutting Abrasive Materials

LONG LIFE

Hard tungsten carbide grit edge for a long life in abrasive materials

FAST, EASY CUTTING

Continuous cutting edge for smooth cutting

LIMITS DUST / DEBRIS

Solid back design collects dust and debris

NEW DESIGN



1 PER BOX PROD NO	DIAMETER		FOR FIXTURES	USE ARBOR	
	IN	MM		SNAP-BACK	STANDARD
30861438RL	4-3/8	111	Capri, Marco & Halo, Mini-Juno	2L	2L
12100538RL	5-3/8	137	Capri, Marco & Halo, Mini-Juno, Lightolier & Halo	2L	2L
30862638RL	6-3/8	162	Capri, Halo, Pathway & Thomas	2L	2L
30863658RL	6-5/8	168	Juno, Progress & Pathway	2L	2L
30864678RL	6-7/8	175	Capri, Hubbell®, Lightolier®, Lithonia®, Marco, Prescolite®, Progress	2L	2L

Use 123CT or 4321 Pilot Drill

HALO is a registered trademark of Halo Lighting, JUNO is a registered trademark of Juno Lighting Inc., LITHONIA is a registered trademark of Lithonia, Inc., LIGHTOLIER is a registered trademark of Lightolier, Inc., and PRESCOLITE is a registered trademark of Prescolite, Inc.

HOLE SAW SELECTION GUIDE

	WOOD	NAIL-EMBEDDED WOOD	NON-FERROUS METAL	PLASTICS & COMPOSITES	METAL	STAINLESS STEEL	DRYWALL/PLASTER	CAST IRON	CEMENT BOARD	ABRASIVES	TILE	STONE
BEST	CARBIDE TIPPED			CARBIDE GRIT	CARBIDE TIPPED			LENOX® DIAMOND™				
BETTER	BI-METAL		BI-METAL				CARBIDE TIPPED	CARBIDE GRIT				
GOOD	CARBIDE GRIT	—	CARBIDE GRIT	CARBIDE TIPPED	CARBIDE GRIT			CARBIDE GRIT	BI-METAL	—	CARBIDE TIPPED	—



RECOMMENDED HOLE SAW RPM

BI-METAL

DIAMETER		MILD	TOOL &	CAST		
IN	MM	STEEL	STAINLESS	IRON	BRASS	ALUM
9/16	14.3	580	300	400	790	900
5/8	15.9	550	275	365	730	825
11/16	17.5	500	250	330	665	750
3/4	19.1	460	230	300	600	690
25/32	19.8	425	210	280	560	630
13/16	20.6	425	210	280	560	630
7/8	22.2	390	195	260	520	585
15/16	23.8	370	185	245	495	555
1	25.4	350	175	235	470	525
1-1/16	27.0	325	160	215	435	480
1-1/8	28.6	300	150	200	400	450
1-3/16	30.2	285	145	190	380	425
1-1/4	31.8	275	140	180	360	410
1-5/16	33.3	260	135	175	345	390
1-3/8	34.9	250	125	165	330	375
1-7/16	36.5	240	120	160	315	360
1-1/2	38.1	230	115	150	300	345
1-9/16	39.7	220	110	145	290	330
1-5/8	41.3	210	105	140	280	315
1-11/16	42.9	205	100	135	270	305
1-3/4	44.5	195	95	130	250	295
1-13/16	46.0	190	95	125	250	285
1-7/8	47.6	180	90	120	240	270
2	50.8	170	85	115	230	255
2-1/16	52.4	165	80	110	220	245
2-1/8	54.0	160	80	105	210	240
2-1/4	57.2	150	75	100	200	225
2-3/8	60.3	140	70	95	190	220
2-1/2	63.5	135	65	90	180	205
2-9/16	65.1	130	65	85	175	200
2-5/8	66.7	130	65	85	170	195
2-11/16	68.3	125	60	80	160	185
2-3/4	69.9	125	60	80	160	185
2-7/8	73.0	120	60	80	160	180
3	76.2	115	55	75	150	170
3-1/8	79.4	110	55	70	140	165
3-1/4	82.6	105	50	70	140	155
3-3/8	85.7	100	50	65	130	150
3-1/2	88.9	95	45	65	130	145
3-5/8	92.1	95	45	60	120	140
3-3/4	95.3	90	45	60	120	135
3-7/8	98.4	85	40	55	110	130
4	101.6	85	40	55	110	130
4-1/8	104.8	80	40	55	110	120
4-1/4	108.0	80	40	55	110	120
4-3/8	111.1	75	35	50	100	105
4-1/2	114.3	75	35	50	100	105
4-5/8	117.5	75	35	50	100	105
4-3/4	120.7	70	35	45	90	95
5	127.0	70	35	45	90	95
5-1/2	139.7	65	30	40	85	90
6	152.4	65	30	40	85	90

CARBIDE TIPPED

DIAMETER		ALUM	PLASTIC	FIBER-GLASS	CERAMIC TILE	PARTICLE BOARD	CAST IRON	COMPUTER FLOORING
IN	MM							
3/4	19.1	1700	3430	250	500	3430	410	550
7/8	22.2	1500	2940	210	430	2940	180	470
1	25.4	1300	2570	190	370	2570	150	410
1-1/8	28.6	1100	2290	170	330	2290	140	370
1-3/8	34.9	900	1870	140	270	1870	110	300
1-1/2	38.1	900	1710	120	250	1710	100	270
1-3/4	44.5	700	1470	110	210	1470	90	240
2	50.8	600	1290	90	190	1290	80	210
2-1/4	57.2	600	1140	80	170	1140	70	180
2-1/2	63.5	500	1030	70	150	1030	60	160
3	76.2	400	860	60	120	860	50	140
3-1/4	82.6	400	790	60	110	790	50	130
3-5/8	92.1	400	710	50	100	710	40	110
3-3/4	95.3	300	690	50	100	690	40	110
4-1/8	104.8	300	620	50	90	620	40	100
4-3/4	120.7	300	540	40	80	540	30	90
5	127.0	200	480	40	80	500	30	90
5-1/2	139.7	200	420	40	70	460	30	80
6	152.4	100	360	30	60	420	30	60

Suggested RPMs only

CARBIDE GRIT

DIAMETER		BRICK, DRYWALL, PORCELAIN, MARBLE CERAMIC TILE	SLATE, FIBERGLASS, CEMENT & PARTICLE BOARD LAMINATES, GRANITE	CAST IRON
IN	MM			
3/4	19.1	800	900	600
25/32	19.8	800	900	600
7/8	22.2	800	900	600
1	25.4	800	900	600
1-1/8	28.6	500	600	400
1-1/4	31.8	500	600	400
1-3/8	34.9	500	600	400
1-1/2	38.1	500	600	400
1-3/4	44.5	500	600	400
2	50.8	400	500	200
2-1/8	54.0	400	500	200
2-1/4	57.2	400	500	200
2-3/8	60.3	200	300	100
2-1/2	63.5	200	300	100
2-9/16	65.1	200	300	100
2-5/8	66.7	200	300	100
3	76.2	200	300	100
3-1/4	82.6	100	200	100
3-5/8	92.1	100	200	100
4	101.6	100	200	100
4-1/8	104.8	100	200	100

Suggested RPMs only

LENOX DIAMOND™ HOLE SAWS

PORCELAIN, CERAMIC, SLATE, GRANITE, MARBLE, GLASS, FIBERGLASS, TRAVERTINE, CEMENT BOARD, LAMINATES

ONE PIECE			STANDARD		
DIAMETER			DIAMETER		
IN	MM		IN	MM	
3/16	5	1500-2000	7/8	22.2	800-1200
1/4	6	2000-2500	1-1/18	28.6	500-900
5/16	8	2000-2500	1-1/4	31.8	500-900
3/8	10	2000-2500	1-3/8	34.9	500-900
1/2	13	2000-2500	1-1/2	38.1	500-900
5/8	15	1500-2000	2	50.8	400-800
3/4	19.1	1500-2000	2-1/2	63.5	200-600

Suggested RPMs only

Suggested RPMs only



METAL AND WOOD DRILLING

LENOX® VARI-BIT® Step Drill Bits	84
Bi-metal Ship Auger Bits	85
Bi-metal Utility Bits	86
Bi-metal Self-Feed Bits	87



LENOX VARI-BIT® STEP DRILL BITS

Drills Fast, Clean, Round Holes

ACCURATE, BURR-FREE HOLES

Patented two flute design cuts fast, clean, round holes

STARTS ON CONTACT

Split point design for faster penetration and less walking

LONG TOOL LIFE

Steam oxide coating adds durability. Enhanced flute design removes chips rapidly. Use of LENOX PROTOOL LUBE® recommended to extend tool life



1 PER PACK PROD NO		HOLE SIZES		# OF HOLE SIZES	SHANK SIZE	
		IN	MM		IN	MM
30881VB1		1/8, 5/32, 3/16, 7/32, 1/4, 9/32, 5/16, 11/32, 3/8, 13/32, 7/16, 15/32, 1/2	3.2, 4.0, 4.8, 5.6, 6.4, 7.1, 7.9, 8.7, 9.5, 10.3, 11.1, 11.9, 12.7	13	1/4	6.4
30882VB2		1/2, 9/16, 5/8, 11/16, 3/4, 13/16, 7/8, 15/16, 1	12.7, 14.3, 15.9, 17.5, 19.1, 20.6, 22.2, 23.8, 25.4	9	3/8	9.5
30883VB3		1/4, 5/16, 3/8, 7/16, 1/2, 9/16, 5/8, 11/16, 3/4	6.4, 7.9, 9.5, 11.1, 12.7, 14.3, 15.9, 17.5, 19.1	9	3/8	9.5
30884VB4		3/16, 1/4, 5/16, 3/8, 7/16, 1/2	4.8, 6.4, 7.9, 9.5, 11.1, 12.7	6	1/4	6.4
30886VB6		3/8, 1/2	9.5, 12.7	2	1/4	6.4
30887VB7		7/8 (for 1/2 conduit)	22.2 (for 12.7 conduit)	1	3/8	9.5
30908VB8		3/16, 1/4, 5/16, 3/8, 7/16, 1/2, 9/16, 5/8, 11/16, 3/4, 13/16, 7/8	4.8, 6.4, 7.9, 9.5, 11.1, 12.7, 14.3, 15.9, 17.5, 19.1, 20.6, 22.2	12	3/8	9.5
30909VB9		7/8, 1-1/8, 1-7/32	22.2, 28.6, 31.0	3	3/8	9.5
30888VB11		7/8, 1-1/8 (for 1/2 and 3/4 conduit)	22.2, 28.6 (for 12.7 and 19.1 conduit)	2	3/8	9.5
30912VB12		7/8, 1-1/8, 1-7/32, 1-1/4, 1-3/8	22.2, 28.6, 31.0, 31.8, 34.9	5	3/8	9.5
30925VBX8		8" (203mm) Extension. Fits 3/8 (9.5mm) shank & larger. 1 per pack.		-	3/8	9.5



**30889889
3 PIECE KIT**
VB1, VB2,
VB3
COMPACT KIT



**30926VBK4
4 PIECE KIT**
VB1, VB2,
VB7, VB8
COMPACT KIT



**30929VB30929
4 PIECE KIT**
VB1, VB3,
VB8, VB12
COMPACT KIT



**30927VBKA6
6 PIECE KIT**
VB1, VB2, VB6,
VB7, VB8, VB11
COMPACT KIT

BI-METAL SHIP AUGER BITS

Tougher than Nails

EXTREME DURABILITY

High speed steel cutting edge for superior durability in nail-embedded wood

LONGER LIFE

High speed steel screw tip increases wear resistance for extended life

FAST, EASY DRILLING

Unique parabolic screw tip pulls the bit through material quickly and effortlessly

RESHARPENABLE

Resharpener with LENOX Diamond File (prod no. 25312DIAF1)



High Speed Steel Cutting Edge



Parabolic Tip



Our bi-metal technology fuses two premium steels together.

PROD NO	HOLE DIAMETER		OVERALL LENGTH		TWIST LENGTH	
	IN	MM	IN	MM	IN	MM
1455507A1016	5/8	16	7-1/2	191	4	102
1455607A1116	11/16	18	7-1/2	191	4	102
1455707A1216	3/4	19	7-1/2	191	4	102
1455807A1316	13/16	21	7-1/2	191	4	102
1455907A1416	7/8	22	7-1/2	191	4	102
1456007A1516	15/16	24	7-1/2	191	4	102
1456107A1616	1	25	7-1/2	191	4	102
1456207A1716	1-1/16	27	7-1/2	191	4	102
1456307A1816	1-1/8	29	7-1/2	191	4	102
1456407A2016	1-1/4	32	7-1/2	191	4	102
1456507A2216	1-3/8	35	7-1/2	191	4	102
1456607A2416	1-1/2	38	7-1/2	191	4	102

PROD NO	HOLE DIAMETER		OVERALL LENGTH		TWIST LENGTH	
	IN	MM	IN	MM	IN	MM
145390080616*	3/8	10	18	457	12	305
145400080716*	7/16	11	18	457	12	305
145410080816	1/2	13	18	457	12	305
145420080916	9/16	14	18	457	12	305
145430081016	5/8	16	18	457	12	305
145440081116	11/16	18	18	457	12	305
145450081216	3/4	19	18	457	12	305
145460081316	13/16	21	18	457	12	305
145470081416	7/8	22	18	457	12	305
145480081516	15/16	24	18	457	12	305
145490081616	1	25	18	457	12	305
145500081716	1-1/16	27	18	457	12	305
145510081816	1-1/8	29	18	457	12	305
145520082016	1-1/4	32	18	457	12	305
145530082216	1-3/8	35	18	457	12	305
145540082416	1-1/2	38	18	457	12	305

*3/8" shank—all others 1/2" shank



1787507 15 PIECE, SELF-FEED BIT/ AUGER KIT

Augers: 7/8", 1-1/8", 1-1/4". Length: 7-1/2"
Self-feed bits: 1-1/2", 1-3/4", 2-1/8", 2-9/16"
Extension: 5-1/2". Five lead screws
Hex Wrench Set

LARGE KIT



BI-METAL UTILITY BITS

Tougher Than Nails

EXTREME DURABILITY

High speed steel cutting edges provide long life in tough applications, including nail-embedded wood

OPTIMIZED FOR CORDLESS DRILLING

Smooth, effortless drilling extends battery life

FAST CLEAN CUTTING

Three cutting edges enhance chip removal for a fast, clean hole

FAST, EASY DRILLING

Aggressive lead screw tip pulls the bit through material quickly and effortlessly



RESHARPENABLE
Resharpener with LENOX
Diamond File (25312DIAF1)

PROD NO	HOLE SIZE		OVERALL LENGTH	
	IN	MM	IN	MM
1094706A1016	5/8*	16	6	152
1094806A1216	3/4	19	6	152
1094906A1416	7/8	22	6	152
1095006A1616	1	25	6	152
1095106A1816	1-1/8	29	6	152
1095206A2016	1-1/4	32	6	152
1095306A2216	1-3/8	35	6	152

*1/4" shank—all others 3/8" shank



Fits Cordless Drill



3 Cutting Edges



Steel Cutting Edge



10954300S
3 PIECE SET
3/4", 7/8", 1"



14787300PS
3 PIECE
PLUMBER'S SET
7/8", 1-1/8", 1-3/8"



10955500K
5 PIECE KIT
3/4", 7/8", 1", 1-1/8",
1-1/4"
COMPACT KIT



14788500PK
5 PIECE
PLUMBER'S KIT
3/4", 7/8", 1", 1-1/8", 1-3/8"
COMPACT KIT

BI-METAL SELF-FEED BITS

Tougher than Nails

EXTREME DURABILITY

High speed steel cutting edge for superior durability in nail-embedded wood

Stays sharper longer

CLEAN HOLES AND EASY REMOVAL

Chamfered edge allows bit to be removed easily after drilling

Flutes remove excess wood chips

FAST, EASY DRILLING

Aggressive lead screw tip pulls the bit through material quickly and effortlessly

INCREASED VALUE

Extra lead screw and wrench included in every package

DEEPER CUTS

Longer shank that cuts 4"x 4" without extension

QUICK CHANGE

Impact hex shank allows for quick changing of the bits



RESHARPENABLE
Resharpener with LENOX
Diamond File (25312DIAF1)



Chamfered Edge & Flutes



Lead Tip Screw



High Speed Steel

PROD NO	HOLE DIAMETER		ENTRANCE FOR PIPE RIGID CONDUIT		ENTRANCE FOR TUBING	
	IN	MM	IN	MM	IN	MM
1787511	1	25	1/2	12.7	7/8	22.2
1787512	1-1/8	29	1/2	12.7	1	25.4
1787513	1-1/4	32	3/4	19	1-1/8	28.6
1787515	1-3/8	35	1	25.4	1-1/4	31.8
1787561	1-1/2	38	—	—	1-3/8	34.9
1787562	1-3/4	45	1-1/4	31.8	1-1/2	38.1
1787563	2	51	1-1/2	38.1	1-7/8	47.6
1787564	2-1/8	54	—	—	2	50.8
1787565	2-1/4	57	—	—	2-1/8	54
1787566	2-9/16	65	2	50	2-1/2	63.5
1787502	3	76	2-1/2	63	2-7/8	73
1787503	3-5/8	92	3	76.2	3-1/2	88.9
1787504	4-5/8	118	4	101.6	4-1/2	114.3

PROD NO	DESCRIPTION	FITS	QTY PER PACK
1787602	Self-Feed Lead Screws	1" - 1-3/8"	5
1787604	Self-Feed Lead Screws	1-1/2" - 2-9/16"	5
1787603	Self-Feed Lead Screws	3" - 4-5/8"	5
1787605	Self-Feed Set Screws	—	5
1787508	Hex Wrench Set, 1/8"	—	2
3084655X	5-1/2" shank extension*	—	1
3084712X	12" shank extension*	—	1
3084818X	18" shank extension*	—	1
25312DIAF1	Diamond File	—	1

*All have 1/2" (13mm) hex shank with 2 set screws to lock BI-METAL SELF-FEED BIT in place

ACCESSORIES



1787505
12 PIECE SELF-FEED KIT
1-3/8", 1-1/2", 2-1/8", 2-9/16"
Extension: 5-1/2" Five lead screws. Hex Wrench Set

LARGE KIT



1787506
16 PIECE SELF-FEED KIT
1-1/8", 1-1/4", 1-3/8", 1-1/2", 1-3/4",
2-1/8", 2-9/16" Extensions: 5-1/2", 12"
Five lead screws Hex Wrench Set

LARGE KIT



1787507
15 PIECE SELF-FEED BIT/ AUGER KIT
Augers: 7/8", 1-1/8", 1-1/4", Length: 7-1/2"
Self-feed bits: 1-1/2", 1-3/4", 2-1/8", 2-9/16"
Extension: 5-1/2", Five lead screws
Hex Wrench Set

LARGE KIT





HAND **TOOLS**

T2™ Hacksaw Blades	91
Hacksaw Frames.....	92
Hand Saws	94
Snips & HVAC Tools	95
Plastic Tubing Cutters.....	96
Tubing Cutters	98
Locking Tradesman Utility Knife & Utility Knives.....	100
Utility Blades, Safety Knife & Blades.....	101
Soft Storage Tool Bags.....	102
Pipe Wrenches & All-In-One Screwdrivers	104



T2™ TECHNOLOGY HACKSAW BLADES

Up to 2X Life

T2 TECHNOLOGY

A new blade design that delivers up to 100% longer blade life versus the prior generation of LENOX hacksaw blades

SHATTER RESISTANT

Bi-metal construction allows blades to bend and flex without breaking

CUTS THROUGH TOUGH METALS:

- Black Pipe
- Unistrut®
- Copper Pipe
- Hardened Steel
- Threaded Rod
- Rebar

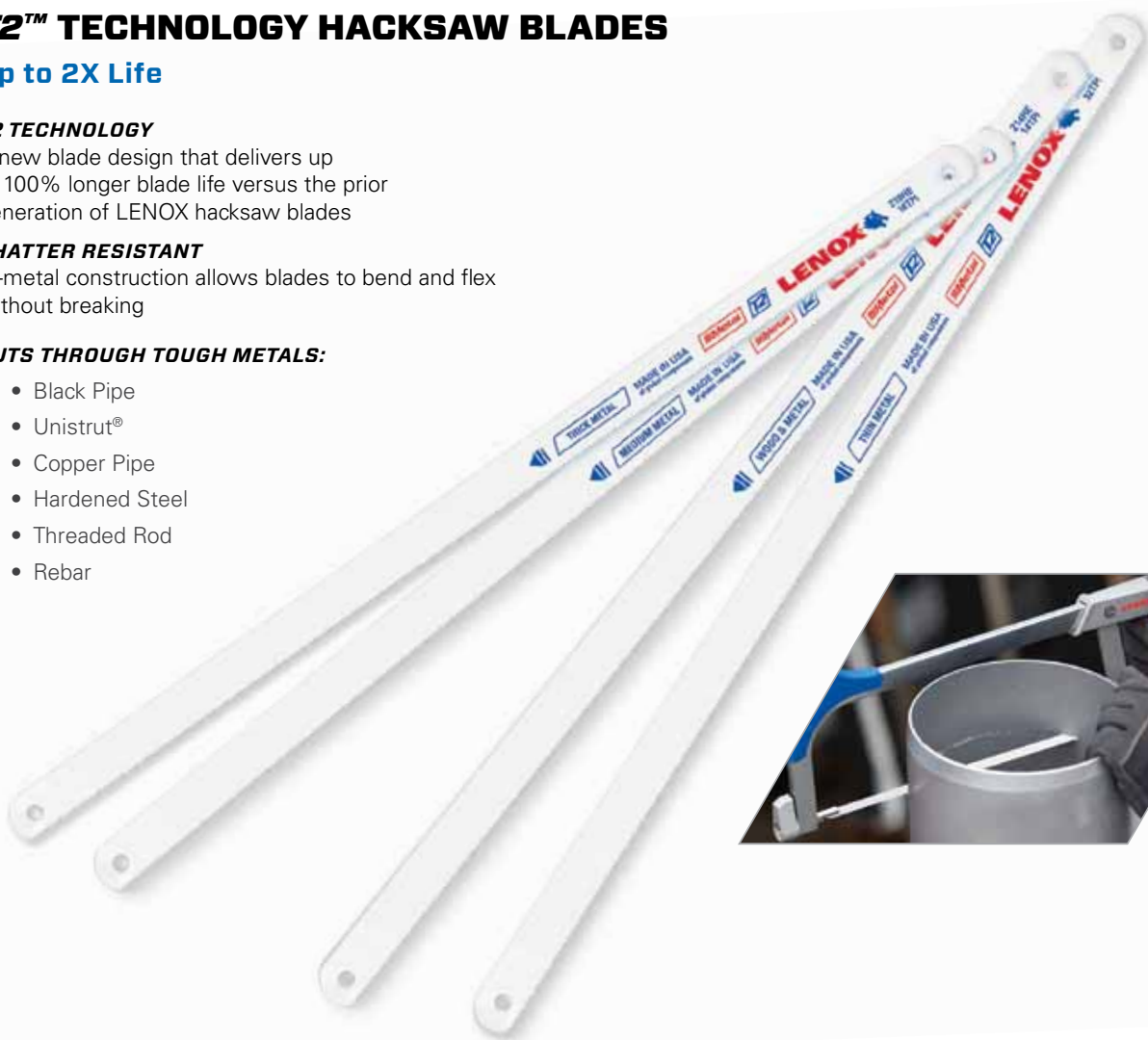

TPI	LENGTH X WIDTH		1-PACK PROD NO	2-PACK PROD NO	10-PACK PROD NO	100-PACK PROD NO	APPLICATION
	IN	MM					
14	12 x 1/2	300 x 12.7	—	—	20143V214HE	—	Wood and Metal
18	10 x 1/2	250 x 12.7	20150S018HE	20163T018HE	20140V018HE	20110018HE	Heavy Metal
18	12 x 1/2	300 x 12.7	20154S218HE	20160T218HE	20144V218HE	20116218HE	Heavy Metal
24	10 x 1/2	250 x 12.7	20151S024HE	23930T024HE	20141V024HE	20111024HE	Medium Metal
24	12 x 1/2	300 x 12.7	20155S224HE	20161T224HE	20145V224HE	20117224HE	Medium Metal
32	10 x 1/2	250 x 12.7	20152S032HE	20164T032HE	20142V032HE	20112032HE	Thin Metal
32	12 x 1/2	300 x 12.7	20156S232HE	20162T232HE	20146V232HE	20118232HE	Thin Metal



HT50 HIGH TENSION HACKSAW

50,000 PSI

HIGHEST TENSION. EVER

Unique I-beam construction allows blade to tension up to 50,000 psi, resulting in fast, straight cuts

COMFORTABLE GRIPS

Rubberized handles allow for confident handling even in wet or cold environments

CONVERT TO A JAB SAW

Accepts any LENOX reciprocating saw blade to be used as a jab saw

CONVENIENT BLADE STORAGE

Store up to 5 extra 12" hacksaw blades in the I-Beam



PROD NO	BLADE SPECIFICATION
12132HT50	12" (300mm) 24TPI Hacksaw Blade



Tension



Use as a Jab Saw



Stores up to 5 Blades



Comfort Grips

5012 LOW PROFILE HACKSAW

40,000 PSI

HIGH TENSION

Allows blade to tension up to 40,000 PSI, resulting in fast, straight cuts

FITS INTO TIGHT SPOTS

Low profile tip easily handles close-quarter cuts

MULTI-PURPOSE

Mount blade at 45 degrees for flush cutting applications

PROD NO	BLADE SPECIFICATION
209205012	12" (300mm) 24TPI Hacksaw Blade



Flush Cutting

88300 LIGHTWEIGHT HACKSAW

30,000 PSI

HIGH TENSION

Saw will tension up to 30,000 PSI

EASILY ADJUST TENSION

ERGONOMIC GRIP

Front handle grip reduces fatigue in continuous cutting applications

MULTI-PURPOSE

Mount blade at 45 degrees for flush cutting applications

PROD NO	BLADE SPECIFICATION
1213188300	12" (300mm) 24TPI Hacksaw Blade



Flush Cutting



Comfort Grips

2012 COMPACT HACKSAW

20,000 PSI

ADJUSTABLE TENSION

Lightweight aluminum beam achieves tension up to 20,000 PSI

ERGONOMIC GRIP

Durable handle enables a confident grip in most work environments

MULTI-PURPOSE

Mount blade at 45 degrees for flush cutting applications

PROD NO	BLADE SPECIFICATION
1805722	12" (300mm) 24TPI Hacksaw Blade



Comfortable Grip

1512 ADJUSTABLE HACKSAW

15,000 PSI

EASILY ADJUST TENSION

Large front tensioning mechanism is easy to hold and adjust up to 15,000 PSI

ERGONOMIC GRIP

Rubberized grip allows for confident handling in any work environment

PROD NO	BLADE SPECIFICATION
1805723	12" (300mm) 24TPI Hacksaw Blade



Comfortable Grip



PVC/ABS

Plastic Pipe Hand Saw

CUTS PLASTIC PIPE EASILY

Cutting teeth cut on the pull stroke and not on the push stroke for safety

COMFORTABLE GRIPS

Rubberized handles allow for confident handling even in cold, hot, wet or dirty environments

FLUSH CUTTING OPTION

Easily mount the blade on the bottom of handle for flush cutting applications



Comfortable Handle



One Step Flush Cuttings

TPI	LENGTH		PROD NO	DESCRIPTION
	IN	MM		
10	12	304	20985HSF12	12" Blade & Handle
10	18	457	20980HSF18	18" Blade & Handle
10	12	304	20982HSB12	12" Replacement Blade
10	18	457	20981HSB18	18" Replacement Blade

FOLDING JAB AND UTILITY SAW

Designed for Cutting Multiple Materials

COMFORTABLE GRIP

Over-molded rubberized grip for a comfortable and secure grip while working

SECURELY HOLDS BLADE

Aluminum locking mechanism prevents blade from being removed during use

ACCOMMODATES HACKSAW BLADE

Ideal for flush cutting applications or when a hacksaw is not available

DIE CAST ALUMINUM CONSTRUCTION



Rotate Blade Out



Loosen Knob to Change Blade

PROD NO	DESCRIPTION	BLADES INCLUDED	APPLICATION
20997TFHS618636	Folding Jab Saw with 2 Blades	635R and 6J6R	Plaster, drywall, wood, plastic and metal cutting
148216J6R	One Pack Replacement Blades		

975 COMPACT HAND HACKSAW

908 CLOSE QUARTER™ SAW

Cut a Wide Variety in Tight Spaces

RUGGED DESIGN

Heavy duty aluminum handle

FITS IN TIGHT SPOTS

Allows for flush cutting applications



20908

20975

PROD NO	DESCRIPTION	TPI	BLADE LENGTH	
			IN	MM
20975975	Compact Hand Saw	10	12	304
20908908	CLOSE QUARTER Saw	10	18	457
20906906	Replacement Blades	32	6	152

SNIPS

Maximum Durability for Long Life

LONG BLADE LIFE

Precision-formed blades for Aviation and Bulldog Snips

Bi-material blades for Offset Snips

ULTIMATE SPRING DURABILITY

Reinforced Chrome Silicon valve-quality wire lasts for a lifetime

COMFORTABLE GRIPS

Over-molded handles won't slip or twist

QUICK IDENTIFICATION

Color coding on both blades and handles plus arrow icons allow for easy tool recognition



PROD NO	DESCRIPTION		CUTTING CAPACITY		COMPETITIVE CROSS REFERENCE			
			SHEET METAL	STAINLESS STEEL	MALCO®	MIDWEST®	WISS®	KLEIN®
22101101	Aviation Snip Left		18 ga	22 ga	M2001/MAXCG1	P6716-L	M1R	1100L
22102102	Aviation Snip Right		18 ga	22 ga	M2002/MAXCG2	P6716-R	M2R	1101R
22103103	Aviation Snip Straight		18 ga	22 ga	M2003/MAXCG3	P6716-S	M3R	1102S
22105105	Aviation Snip Bulldog		16 ga	20 ga	M2005/MAXCG5	P6716-B	M5R	2103
22206206	Offset Snip Left		18 ga	22 ga	M2006/MAXCG6	P6510-L	M6R	2100L
22207207	Offset Snip Right		18 ga	22 ga	M2007/MAXCG7	P6510-R	M7R	2101R

HVAC TOOLS

Precision Sheet Metal Fabrication Tools

ULTIMATE SPRING DURABILITY

Reinforced Chrome Silicone valve-quality wire lasts for a lifetime

COMFORTABLE GRIPS

Over-molded handles won't slip or twist



PROD NO	DESCRIPTION		CUTTING CAPACITY		COMPETITIVE CROSS REFERENCE			
			SHEET METAL	STAINLESS STEEL	MALCO®	MIDWEST®	WISS®	KLEIN®
22208C3	3 Blade Crimper		18 ga	22 ga	C3	—	HC3V	—
22209C5	5 Blade Crimper		18 ga	22 ga	C5	FCT-M-C5	HC5V	86550
22210S2	3" Seamer		18 ga	22 ga	S2	FCT-M-S1	HS1V	86553
22211N2	1" V Notcher		18 ga	22 ga	N2	—	—	—
22212SL1	Snap Lock Punch		18 ga	22 ga	SL1	FCT-M-L1	—	—
22213PDC4R	Pipe Duct Cutter		18 ga	22 ga	4R	FCT-M-P1	M14R	—

Malco is a registered trademark of Malco Products, Inc. Midwest is a registered trademark of Midwest Tool and Cutlery Company
Wiss is a registered trademark of Cooper Industries, Inc. Klein is a registered trademark of Klein Tools.



S1 PEX TUBING CUTTER

Perfect Cuts. Straight and Easy.

PERFECT CUTS. STRAIGHT AND EASY.

Serrated stainless steel blade requires less force to make a cut, leaving a flush end

COMFORTABLE GRIPS

Rubberized handles allow for confident cutting even in wet or dirty environments

EASY OPEN & CLOSE

Conveniently positioned locking latch allows for true one-handed operation of spring-loaded cutter

**CUTS UP TO 1" NOMINAL
(1-5/16" MAX. OD)**



Straight Cuts

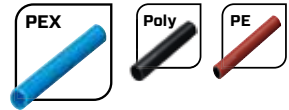

PROD NO	DESCRIPTION
12121S1	PEX Cutter
12125S1B	Plastic Tubing Cutter Replacement Blade

S2 CPVC TUBING CUTTER

Durable Construction

PERFECT CUTS. STRAIGHT AND EASY.

High carbon steel blade cuts rigid plastic tubing with a single cut

COMFORTABLE GRIPS

Rubberized handles allow for confident cutting even in wet or dirty environments

DURABLE CONSTRUCTION

Cast aluminum body stands up to rugged, repeated use

EASY OPEN & CLOSE

Conveniently positioned locking latch allows for true one-handed operation of spring-loaded cutter

**CUTS UP TO 1" NOMINAL
(1-5/16" MAX. OD)**



Easy Open & Close

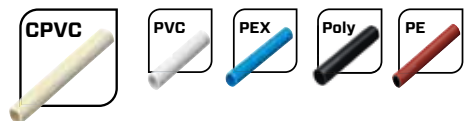

PROD NO	DESCRIPTION
12122S2	CPVC Cutter
12126S2B	Plastic Tubing Cutter Replacement Blade

R1 PVC TUBING CUTTER

Easy Ratcheting

PERFECT CUTS. STRAIGHT AND EASY.

Specifically designed jaw holds pipe in place while cutting with stainless steel blade

COMFORTABLE GRIPS

Rubberized handles allow for confident cutting even in wet or dirty environments

EASY OPEN & CLOSE

Conveniently positioned release button allows for true one-handed operation of ratcheting cutter, while locking tab secures blade in place

**CUTS UP TO 1-1/4" NOMINAL
(1-5/8" MAX. OD)**



Easy Ratcheting



One-Handed Operation

PROD NO	DESCRIPTION
12123R1	PVC Cutter
12127RB1	Plastic Tubing Cutter Replacement Blade

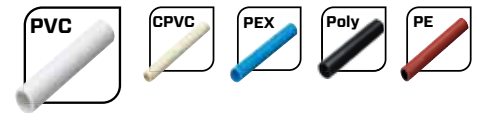

R2 PVC TUBING CUTTER

One-Handed Operation

PERFECT CUTS. STRAIGHT AND EASY.

Specifically designed jaw holds pipe in place while cutting with high-carbon steel blade

ONE-HANDED RATCHETING

One of the only large diameter cutters than can be ratcheted with just one hand

EASY OPEN

Pull both handles apart to quickly start the next cut

**CUTS UP TO 2" NOMINAL
(2-3/8" MAX. OD)**



Easy Ratcheting



One-Handed Operation

PROD NO	DESCRIPTION
12124R2	PVC Cutter
12128R2B	Plastic Tubing Cutter Replacement Blade

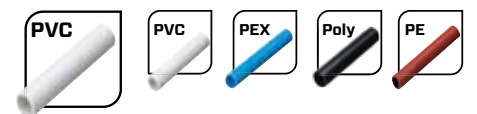



TUBING CUTTERS

Ergonomically Designed for Professional Performance

WON'T WALK WHILE CUTTING

Four roller tracking system keeps tube from threading

PROFESSIONAL DEBURRING

Cleanly and easily deburr pipes with the replaceable machinist's reamer

WILL NOT DAMAGE CUTTING WHEELS

Full-stop feed system prevents wheels and rollers from coming into contact

EASY TO USE

Change out wheels quickly & easily

CONVENIENT STORAGE

Store an extra cutting wheel in the handle



PROD NO	DESCRIPTION	TUBE DIAMETER RANGE		NUMBER OF WHEELS
		IN	MM	
21008TC58	Copper Cutting	1/8–5/8	3–16	1
21009TC1	Copper Cutting	1/8–1	3–25	2
21010TC118	Copper Cutting	1/8–1-1/8	3–29	2
21011TC138	Copper Cutting	1/8–1-3/8	3–35	2
21012TC134	Copper Cutting	1/8–1-3/4	3–45	2
21013TC258	Copper/Plastic Cutting	1/4–2-5/8	6–67	2



21008TC58



21009TC1



21010TC118



21011TC138



21012TC134



21013TC258

TIGHT SPACE TUBING CUTTERS

Cuts You Out of a Tight Spot

LESS BURR. MORE CUTS.

Optimized blade geometry of shock-resistant steel

COMPACT DESIGN FOR TIGHT SPOTS

Non-slip grooved cast aluminum body only needs 1/2" clearance to cut

NO RUSTING

Stainless steel rollers protect the cutter from corrosion

QUICK IDENTIFICATION

Color coding for easy tool recognition and cutting direction



PROD NO	DESCRIPTION	TUBE DIAMETER RANGE		NUMBER OF WHEELS
		IN	MM	
14830TS12	Copper Cutting	1/2	13	1
14831TS34	Copper Cutting	3/4	19	1
14832TS1	Copper Cutting	1	25	1
14833TSK	3 pc Kit	1/2, 3/4, 1	13,19,25	



14830TS12



14831TS34



14832TS1



14833TSK

Tubing Cutter Accessories

DESCRIPTION	1-PACK	2-PACK	6-PACK
	PROD NO	PROD NO	PROD NO
Stainless Steel Cutting Wheels*	—	21193TCW158SS2	21015TCW158SS
Plastic Cutting Wheels***	—	21191TCW158P2	21016TCW158P
Copper Cutting Wheels*	—	21192TCW158C2	21017TCW158C
Small Copper Cutting Wheels**		14829TSB	
Replacement Deburrer fits 21011 & 21012 TC	21024TCD	—	—
Tubing Cutter Handle Screw****	21196TCHS	—	—

* Fits 21010, 21011, 21012, 21013 and many other competitors' Tubing Cutters

** Fits LENOX Product No 21008, 21009, 14830, 14831, 14832

*** Fits 21013

**** Fits LENOX Product No 21010-21013 only



Small Copper



Stainless Steel



Plastic



Copper



Deburrer



LOCKING TRADESMAN UTILITY KNIFE

Works Big. Folds Small.

EASY OPEN & CLOSE

Secure locking mechanism

COMFORT GRIP

Ergonomic rubberized grip

MULTI-USE TOOL

Bottle opener, screwdriver and pipe reamer

BUILT-IN WIRE STRIPPER

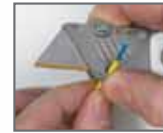

Wire Stripping



Pipe Reamer



Screwdriver



Bottle Opener

PROD NO	DESCRIPTION
10771FLK1	LENOX Gold® Locking Tradesman Utility Knife

UTILITY KNIVES

Durable Construction and Comfortable Grip for Extended Use

EXTREMELY DURABLE STAINLESS STEEL NOSE

One piece titanium coated nose resists wear and eliminates spreading

LONGEST LASTING UTILITY BLADES

Three shatterproof titanium edge blades included

EASY BLADE CHANGE

Quick blade release allows rotation or changing of blade without opening handle

INTERNAL BLADE STORAGE

Retractable knife stores up to five blades

Fixed knife stores up to ten blades

NO TOOL NEEDED TO OPEN



PROD NO	DESCRIPTION
20353SSRK1	LENOX Gold Quick Change Retractable Knife
20354SSFK1	LENOX Gold Fixed Blade Knife

UTILITY BLADES

Titanium Edge for Maximum Blade Life

LASTS LONGER

High speed steel edge with titanium coating keeps blades cutting after others have quit

SHATTERPROOF

Patented bi-metal construction allows blades to bend and flex without breaking

MAKES DEEPER CUTS

Four notch design allows blade to extend further

FITS ALL STANDARD UTILITY KNIVES

CUTS THE TOUGHEST MATERIALS

- Dry wall
- Insulation
- Flooring
- Roofing and more



DISPENSERS

- Easy to use
- Dispenses one or five blades at a time
- 50 packs and 100 packs include dispensers

DESCRIPTION	5-PACK	50-PACK	100-PACK
	PROD NO	PROD NO	PROD NO
LENOX Gold Utility Knife Blade	20350GOLD5C	20351GOLD50D	20352GOLD100D

SELF-RETRACTING SAFETY KNIFE & BLUNT TIP SAFETY BLADES

A Safety Blade that Works

SMOOTH SELF-RETRACTION

Spring loaded shuttle

COMFORTABLE, NON-SLIP HANDLE

Ergonomic design

DUAL FUNCTION

Utility knife and box cutter settings

NO TOOL NEEDED FOR BLADE CHANGE

Quick blade changes

STORES UP TO 5 BLADES



INCREASED SAFETY

Blunt tip design

SHATTERPROOF

Patented bi-metal construction
Bends and flexes without breaking

LONG BLADE LIFE

High speed steel edge

PROD NO	DESCRIPTION
20366SRK1	Self-Retracting Safety Knife
20367BLUNT5C	Blunt Tip Safety Blade 5 pack
20368BLUNT50D	Blunt Tip Safety Blade 50 pack with Dispenser



SOFT STORAGE TOOL BAGS

GET ORGANIZED

Multiple pockets and storage options allow for easily locating the right tool

FUNCTIONAL DESIGN

Padded shoulder straps make carrying comfortable

Reflective materials make bag easy to find in darkness

Red liner helps to easily locate tools

HOLDS UP TO THE JOB

Water-resistant materials and reinforced rivets to withstand tough job site use



Tools not included

ELECTRICIAN'S TOTE

PROD NO	DESCRIPTION
1787422	10" Electrician's Tote

- 5 Open storage areas
- 12 Exterior pockets
- 16 Elastic loops
- 8 Interior pockets
- Tape measure clip
- Key clip
- Tape holder loop
- Small parts bin
- Clip on handle
- Padded shoulder strap
- Reflective material
- Reinforced rivets
- Water-resistant bottom
- Protective pad feet on bottom



Tape Loop



Key Clip



Handle Clip

CONTRACTOR'S TOOL BAG

PROD NO	DESCRIPTION
1787426	16" Contractor's Tool Bag

- Large open-mouth bag
- 14 Interior pockets
- Small parts bin
- Padded shoulder strap
- Reflective material
- Reinforced water-resistant bottom
- Protective pad feet on bottom



Small Parts Bin

PLUMBER'S TOTE

PROD NO	DESCRIPTION
1787474	19" Plumber's Tote

- 9 Exterior pockets
- 14 Interior pockets
- 10 Elastic loops
- Hacksaw pocket
- Tape measure clip
- Tape holder loop
- Foldable handle
- Padded shoulder strap
- Reflective material
- Hard plastic waterproof bottom



Hacksaw not included



Tape Loop

BUCKET TOOL ORGANIZER

PROD NO	DESCRIPTION
1787473	Bucket Tool Organizer

- 22 Exterior pockets
- 12 Interior pockets
- Hammer loop
- Tape hold loop
- Foldable handle
- Padded shoulder strap
- Side clips secure the organizer
- Reflective material



Bucket not included



Shoulder Strap



Side Clip



PIPE WRENCHES

Built for Extreme Durability

GRIPS TIGHTLY

Hardened teeth are ideal for most hard pipes, bolts and couplings

WITHSTANDS HIGH TORQUE

Enhanced durability for maximum torque

REDUCES HAND FATIGUE (CAST ALUMINUM)

Lightweight cast aluminum handle creates less arm stress



	PROD NO	SIZE		PIPE CAPACITY		RIDGID® COMPETITIVE CROSS REFERENCE	
		IN	CM	IN	MM	CAT NO	MODEL NO
CAST ALUMINUM	2382010ALPW	10	25	1-1/2	40	31090	810
	2382112ALPW	12	30	2	50	47057	812
	2382214ALPW	14	36	2	50	31095	814
	2382318ALPW	18	46	2-1/2	65	31100	818
	2382424ALPW	24	61	3	80	31105	824
	2382536ALPW	36	91	5	125	31110	836
	2382648ALPW	48	122	6	150	31115	848
HEAVY-DUTY CAST IRON	2381208HDPW	8	20	1	25	31005	8
	2381310HDPW	10	25	1-1/2	40	31010	10
	2381412HDPW	12	30	2	50	31015	12
	2381514HDPW	14	36	2	50	31020	14
	2381618HDPW	18	46	2-1/2	65	31025	18
	2381724HDPW	24	61	3	80	31030	24
	2381836HDPW	36	91	5	125	31035	36
	2381948HDPW	48	122	6	150	31040	48

RIDGID® is a trademark of Ridge Tool Company

ALL-IN-ONE SCREWDRIVERS

More Torque. More Power.

COMFORTABLE GRIP

Slip-resistant ergonomic grip for maximum torque

REDUCED STRIPPING

25% thicker nut driver for longer life

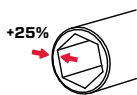

PROD NO	DESCRIPTION	⊕ #1	⊕ #2	⊖ 3/16"	⊖ 1/4"	⊙ 1/4"	⊙ 5/16"	⊖ #2	⊖ #3	⊙ 3/8"
23931	6-1 Screwdriver	•	•	•	•	•	•	—	—	—
23932	9-1 Screwdriver	•	•	•	•	•	•	•	•	•

THE LENOX GUARANTEE

Our products are backed by the LENOX limited warranty. We warrant that our products are free from defects in materials and workmanship and that these products will perform as described under normal use and service. This warranty of quality is valid for 90 days from confirmed date of purchase. Except as expressly set forth herein, LENOX makes no other warranties, express or implied, with regard to products, and expressly disclaims any warranty of fitness for a particular purpose. This warranty gives you specific legal rights and you may also have other rights which vary from state to state. Use our products only in accordance with LENOX instructions.

GENERAL SAFETY TIPS

LENOX is involved in the Voluntary Protection Program (VPP), designed to recognize and promote effective safety and health management. Our employees agree to participate in the program and work with management to assure a safe and healthful workplace under an established set of criteria. Several benefits to the VPP are the motivation to work safely, reduced workers' compensation costs and fewer lost workdays due to injuries. This all results in better quality and productivity.

We are also very concerned for the safety of the people using our products. Here are a few tips to remind you to use all safety measures to avoid any type of injury:

1. Tools can injure – handle with care.
2. When cutting through walls, be sure you're clear of electrical wires behind the wall.
3. Power tools can bind and kick back. Be sure to hold them firmly and keep yourself out of the recoil path.
4. Wear eye protection and other appropriate safety equipment when using tools.
5. Make sure ladders or staging are stable before using.
6. When using drilling accessories, a power tool with a torque limiting device is recommended.
7. Use power tools in accordance with manufacturers' instructions and recommendations for accessories.

TRADEMARK INFORMATION

INCONEL is a registered trademark of Huntington Alloys Corporation.

DURANICKEL, INCOLOY, MONEL and NI-SPAN C are registered trademarks of Inco Alloys International, Inc.

RENE 41 is a registered trademark of Teledyne Industries, Inc.

LITHONIA is a registered trademark of Lithonia, Inc.

LIGHTOLIER is a registered trademark of Lightolier, Inc.

PRESCOLITE is a registered trademark of Prescolite, Inc.

HUBBELL is a registered trademark of Hubbell, Inc.

MILWAUKEE is a registered trademark of Milwaukee Electric Tool Corp.

DEWALT is a registered trademark of Black & Decker Corporation.

MORSE is a registered trademark of M.K. Morse Company.

BOSCH is a registered trademark of Robert Bosch Tool Corporation.

NIMONIC is a registered trademark of Henry Wiggin & Company, Ltd.

KLEIN is a registered trademark of Klein Tools.

MALCO is a registered trademark of Malco Products, Inc.

MIDWEST is a registered trademark of Midwest Tool and Cutlery Company.

WISS is a registered trademark of Cooper Industries, Inc.

RIDGID is a registered trademark of Ridge Tool Company.

NICHOLSON is a registered trademark of Cooper Hand Tools.

STARRETT is a registered trademark of the L.S. Starrett Company.

LENOX 



 facebook.com/lenoxtools

 twitter.com/lenoxtools

 youtube.com/lenoxtools

Customer Service: 800-628-8810
Technical Support: 800-642-0010
lenoxtools.com

5208A
301 Chestnut Street, East Longmeadow, MA 01028-0504 USA
©1/2013 LENOX, Newell Rubbermaid